

Conveyor Accessories

Package Stops

Dead Type

Dead type Package Stops are simply placed on bed section of gravity wheel and 1-3/8 in. roller conveyor. Styles A, B, or C can be used to lift or stop cartons or boxes. Easily attached to conveyor.

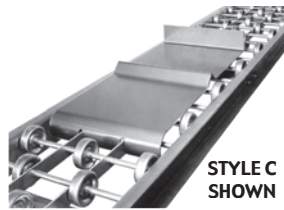

Dead Stop

Between Rail Width	Overall Frame Width	Package Stop Width
10"	12"	9"
13"	15"	12"
16"	18"	15"
22"	24"	21"

- 3 Styles-4 Widths
- 12 ga. Steel



STYLE "A"

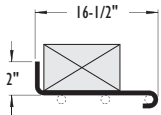

STYLE "B"

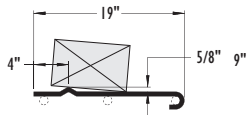

STYLE "C"

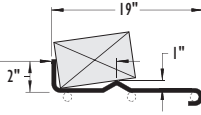

Angle End Stop

Angle End Stop mounts to end of conveyor for stopping boxes, cartons, etc. Bolts to top flange of conveyor channels. Available in all standard conveyor widths.

- 1-1/2 in. x 1-1/2 in. x 12 ga. powder painted steel for 190-LR, 138-ACC, 190-ACC, 138-NSP, 190-NSP, 190-ACZ, SW, 1-3/8SR, 19SR, & 20SR conveyors
- 2 in. x 2 in. x 1/4 in. powder painted steel for 2-1/2 & 2-5/8 in. gravity



Terminating End Stop

Terminating End Stops mount to end of conveyor for stopping boxes, cartons, etc. Bolts to top flange of conveyor channels. Available in all standard conveyor widths.

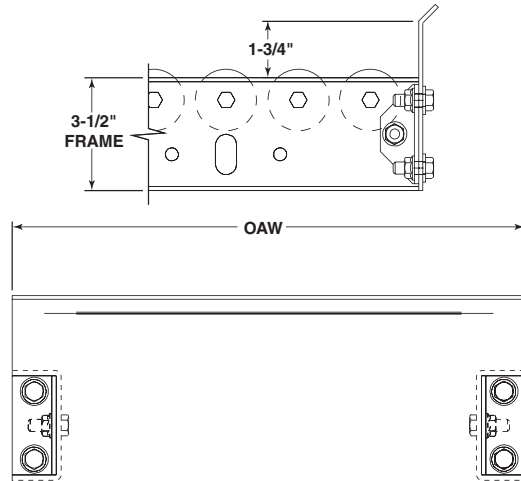

Raised End Roller

Raised End Roller Stop can be mounted at end or any desired location along conveyor (some drilling may be required). Steel angle brackets hold 2-1/8 in. dia. x 1/8 in. wall galvanized roller with 7/16 in. hex shaft. Bolts to top flange of conveyor channels. For Models 190-LR, 138-ACC, 190-ACC, 190-ACZ, SW, 1-3/8SR, 19SR, & 20SR.

- Available in all standard widths.
- Capacity: 150 lbs. live load capacity at 65 fpm.

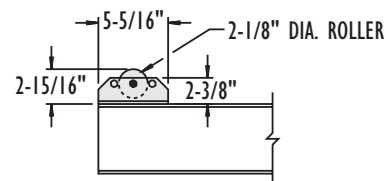

Hand Operated Blade/Roller

Hand Operated Stops are used where manual line control is required such as assembly work stations, shipping areas, etc. Can be mounted to underside of 190-LR, 138-ACC, 190-ACC, 138-NSP, 190-NSP, 190-ACZ, 1-3/8SR, 19SR & 20SR Conveyors.

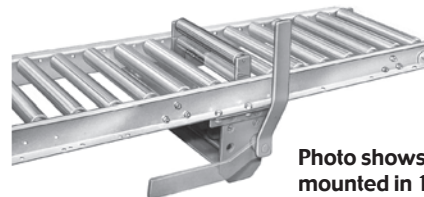

Photo shows Package Stop mounted in 1-3/8 in. dia. Gravity Roller Conveyor.

• Standard Specifications

CAPACITY-Blade 50 lbs. for 1-3/8 in. roller and 150 lbs. for 1.9 in. roller. 1-3/8 in. dia. roller 50 lbs., 1.7 in. dia. roller 150 lbs. All are live load capacities at 65 FPM.

BEARINGS-Cam roller bearings to absorb impact.

OPERATION-Hand operated lever to raise or lower stop. Can be used in normally up or down positions.

STOP-7 ga. formed angle 1 in. x 1-1/2 in. for 1-3/8 in. conveyors, 1-1/2 in. x 1-1/2 in. for 1.9 in. & 2.0 in. conveyors. Roller 1-3/8 in. dia. x 18 ga. galvanized steel for 1-3/8 in. conveyors. 1.7 in. dia. x 13 ga. unplated steel roller for 1.9 in. & 2.0 conveyors.

STROKE-1-7/8 in. above rollers.

Conveyor Accessories

Package Stops (Continued)



Foot Operated Blade/Roller

Foot Operated Stops are used where manual line control is required such as assembly work stations, shipping areas, etc. Can be mounted to underside of SSR, 19SR, & 20SR Conveyors.

• Standard Specifications

CAPACITY—Blade 50 lbs. for 1-3/8 in. roller and 150 lbs. for 1.9 in. roller. 1-3/8 in. dia. roller 50 lbs., 1.7 in. dia. roller 150 lbs. All are live load capacities at 65 FPM.

OPERATION—Foot operated lever to raise or lower stop.

STOP—Blade 1/4 in. steel plate, roller 1-3/8 in. dia. x 18 ga. galvanized steel for 1-3/8 in. conveyors. 1.7 in. dia. x 13 ga. unplated steel roller for 1.9 in. & 2.0 conveyors.

POSITION—Supplied normally down. Can be supplied normally up, specify.

STROKE—2 in. above roller.

Turning Wheel

Turning Wheels are used in converging 30° and 45° spur applications. Also used at 90° (right angle) transfers where Traffic Cops, Package Stops and other product flow controlling devices are used. Wheel is mounted on adjustable bracket to insure proper package orientation through transfer. Can be mounted to slider bed or side channels of powered and gravity conveyors—specify model where applicable.

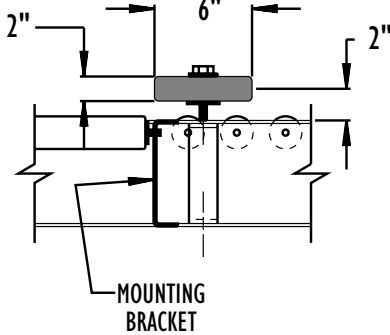

VIEW "A-A"



Mounting Hardware for 6-1/2" Channel Only

