

ASSEMBLY INSTRUCTIONS**CAUTION**

INSPECT CONTENTS IMMEDIATELY AND FILE CLAIM WITH DELIVERING CARRIER FOR ANY DAMAGE. **SAVE YOUR BOX AND ALL PACKING MATERIALS.** YOU ARE RESPONSIBLE FOR DAMAGE TO YOUR UNIT IF RETURNED IMPROPERLY PACKED.

Parts List

#	qty	description
#1	2	Wire Shelf
#2	4	Posts
#3	2	(bags of four) Aluminum Split Sleeves with Retaining Rings
#4	1	Spacer Box
#5	2	End Panels
#6	4	$\frac{3}{8}$ " - 16" x 1 $\frac{1}{4}$ " Tamper Proof Bolts
#7	1	Back Panel (48" & 60" units come in two pieces)
#8	1	Left Door Panel
#9	1	Right Door Panel
#10	1	Bag of bushings (only for units with Eaglegard® finish)
#11		Optional Center Shelves if ordered. Quantities may vary.

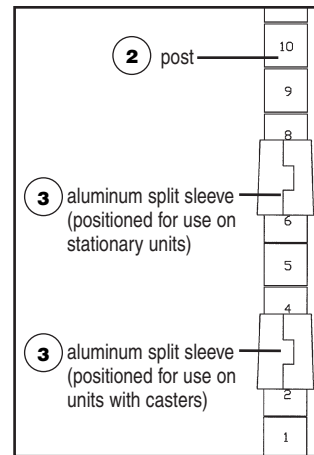
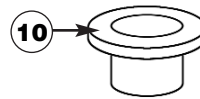

figure 1

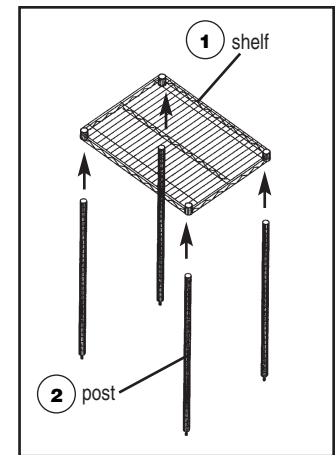

figure 2

1 Install shelves

(NOTE: Start with bottom shelf first.)

- Place (3) split sleeve on each (2) post as shown in figure 1. Note split sleeves are tapered thin at top and thick at bottom. Make sure rib on inside of sleeve is seated into groove of post.
- Take (1) shelf and insert posts through the collar from the bottom until split sleeves are snugly seated within collars as shown in figure 2. Place retaining rings off to the side until later.
- Working from bottom up, repeat steps A & B until all optional shelves are installed. Once the bottom shelf and all optional shelves are in place, take the remaining shelf and install at the very top of the posts.

(continued on back page)

EG9837 Revised 03/08

Security Unit

ASSEMBLY INSTRUCTIONS

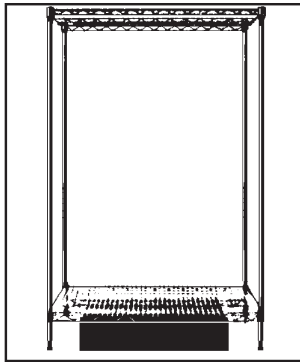

figure 3

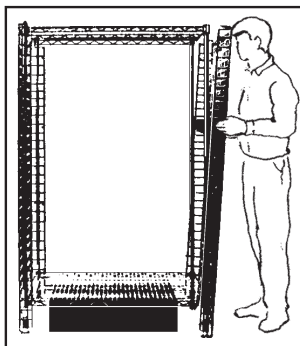

figure 4

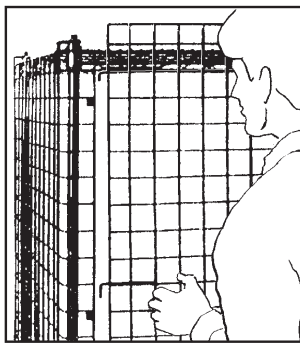

figure 5

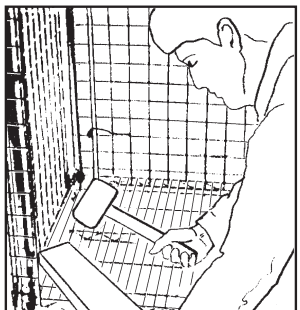

figure 6

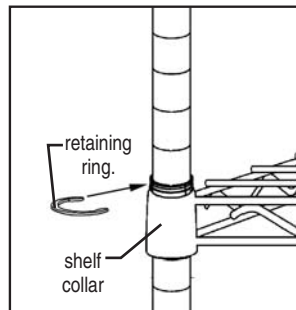

figure 7

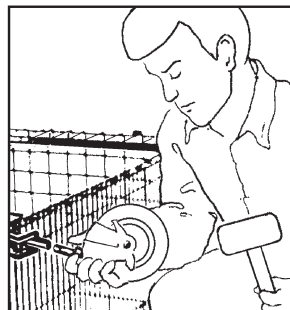

figure 8

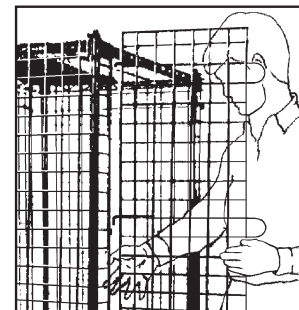

figure 9

2 End Panels

(NOTE: Additional shelves cannot be added once the end panels are in place.)

- A. Take assembled unit and set over (4) spacer box (same box that the shelves were packed in) as shown in *figure 3*. Lift bottom shelf off split sleeves so shelf rests on top of spacer box and posts touch the floor.
- B. Place (5) end panels in position as shown in *figure 4*. Note end panels have large wire loops at bottom and small wire loops at the top. Tip unit slightly so bottom loops slide over bottom of posts and then fit over the top of the posts. Secure in place using (6) bolts.

3 Back Panels

Place (7) back panel in position as shown in *figure 5*. Note: 36" units have one panel, and 48" and 60" have two panels. Use the retaining clip that is provided to secure the back panel(s) to all shelves except bottom.

4 Bottom Shelf

Holding the bottom shelf with one hand, remove the spacer box. Using both hands, gently lower the bottom shelf onto the split sleeves. Seat the bottom shelf by gently tapping the corners with a mallet and board as shown in *figure 6*. Secure the back panel(s) to bottom shelf with retaining clip.

5 Split Sleeve Retaining Rings

On each shelf corner collar (four per shelf), make sure the split sleeve groove, located at the top of each split sleeve, is accessible. Gently tap the retaining ring into the groove of each split sleeve as shown in *figure 7*.

6 Casters or Dolly Truck

If your unit has casters, assemble them as shown in *figure 8*. If your unit is mounted on a dolly truck, mount it at this time by placing the unit on the truck and fastening with bolts from the underside of the truck into the bottom of the posts. These bolts are provided with the dolly truck.

7 Door Panels

Note: If the model number of your unit has a suffix "E" (example: SC2448E), indicating Eaglegard® epoxy finish, insert (10) bushings into hinge tubes of end panels before installing doors.

Hang (8) left door panel and (9) right door panel as shown in *figure 9*. Your Security Unit is now ready for use.

(End)