



⚠ WARNING This equipment should not be installed, operated or maintained by any person who has not read and understood all the contents of this manual. Failure to read and comply with the contents of this manual can result in serious bodily injury or death, and/or property damage. Record the lot and serial number in the space provided below.

Lot Number: _____

Serial Number: _____

Table of Contents

1.0	IMPORTANT INFORMATION AND WARNINGS.....	1
2.0	TECHNICAL INFORMATION.....	2
3.0	PREOPERATIONAL PROCEDURES.....	2
4.0	OPERATION	3
5.0	INSPECTION.....	3
6.0	MAINTENANCE.....	5
7.0	WARRANTY	6
8.0	PARTS LIST	6

1.0 Important Information and Warnings

1.1 Terms and Summary

This manual provides important information for personnel involved with the installation, operation and maintenance of this product. Although you may be familiar with this or similar equipment, it is strongly recommended that you read this manual before installing, operating or maintaining the product.

Danger, Warning, Caution and Notice – Throughout this manual there are steps and procedures that can present hazardous situations. The following signal words are used to identify the degree or level of hazard seriousness.

⚠ DANGER Danger indicates an imminently hazardous situation which, if not avoided, **will** result in **death or serious injury**, and property damage.

⚠ WARNING Warning indicates an imminently hazardous situation which, if not avoided, **could** result in **death or serious injury**, and property damage.

⚠ CAUTION Caution indicates a potentially hazardous situation which, if not avoided, **may** result in **minor or moderate injury** or property damage.

NOTICE Notice is used to notify people of installation, operation, or maintenance information which is important but not directly hazard-related.

This manual chain hoist is designed and manufactured to lift and lower a load manually within a normal work environment. Movement in the horizontal direction is also enabled by combining with a trolley. The operation of a hoist involves more than activating the hoist's controls. Per the ANSI/ASME B30 standards, the use of a hoist is subject to certain hazards that cannot be mitigated by engineered features, but only by the exercise of intelligence, care, common sense, and experience in anticipating the effects and results of activating the hoist's controls. Use this guidance in conjunction with other warnings, cautions, and notices in this manual to govern the operation and use of your hoist.

1.2 Shall's and Shall Not's for Operation

⚠ WARNING

Improper operation of a hoist can create a potentially hazardous situation which, if not avoided, could result in **death or serious injury**, and substantial property damage. To avoid such a potentially hazardous situation **THE OPERATOR SHALL:**

- **NOT** use hoist before reading Owner's Manual.
- **NOT** lift more than rated load for the hoist.
- **NOT** operate a hoist which has been modified without the manufacturer's approval or certification to be in conformity with applicable OSHA regs.
- **NOT** operate hoist when it is restricted from forming a straight line from hook to hook in the direction of loading.
- **NOT** use hoist with twisted, kinked, damaged, or worn chain.
- **NOT** use damaged hoist or hoist that is not working properly.
- **NOT** operate a malfunctioning or unusually performing hoist.
- **NOT** use the hoist to lift, support, or transport people.
- **NOT** lift loads over people.
- **NOT** remove or obscure the warnings on the hoist.
- **NOT** use load chain as a sling or wrap load chain around load.
- **NOT** use in a way that causes either hook to be side loaded.
- **NOT** apply the load to the tip of the hook or to the hook latch.
- **NOT** use hoist if hook latch is missing or malfunctioning.
- **NOT** apply load unless load chain is properly seated in the load sheave.
- **NOT** use the hoist in such a way that could result in shock or impact loads being applied to the hoist.
- **NOT** attempt to lengthen the load chain or repair damaged load chain or hand chain.
- **NOT** operate beyond the limits of the load chain travel.
- **NOT** leave load supported by the hoist unattended unless specific precautions have been taken.
- **NOT** allow the chain, or hook to be used as an electrical or welding ground.
- **NOT** allow the chain, or hook to be touched by a live welding electrode.
- **NOT** operate a hoist on which the safety placards or decals are missing or illegible.
- Be familiar with operating controls, procedures, and warnings.
- Make sure the unit is securely attached to a suitable support before applying load.
- Make sure load slings or other approved single attachments are properly sized, rigged, and seated in the hook saddle.
- Take up slack carefully - make sure load is balanced and load-holding action is secure before continuing.
- Make sure all persons stay clear of the supported load.
- Protect the hoist's load chain from weld splatter or other damaging contaminants.
- Report Malfunctions or unusual performances (including unusual noises) of the hoist and remove the hoist from service until the malfunction or unusual performance is resolved.
- Warn personnel before lifting or moving a load.
- Warn personnel of an approaching load.

⚠ CAUTION

Improper operation of a hoist can create a potentially hazardous situation which, if not avoided, could result in minor or moderate injury, or property damage. To avoid such a potentially hazardous situation **THE OPERATOR SHALL:**

- Maintain a firm footing or be otherwise secured when operating the hoist.
- Check brake function by tensioning the hoist prior to each lift operation.
- Use hook latches. Latches are to retain slings, chains, etc. under slack conditions only.
- Make sure the hook latches are closed and not supporting any parts of the load.
- Make sure the load is free to move and will clear all obstructions.
- Avoid swinging the load or hook.
- Make sure hook travel is in the same direction as shown on controls.
- Inspect the hoist regularly, replace damaged or worn parts, and keep appropriate records of maintenance.
- Use the hoist manufacturer's recommended parts when repairing the unit.
- Lubricate load chain per hoist manufacturer's recommendations.
- **NOT** allow your attention to be diverted from operating the hoist.
- **NOT** allow the hoist to be subjected to sharp contact with other hoists, structures, or objects through misuse.
- **NOT** adjust or repair the hoist unless qualified to perform such adjustments or repairs.
- **NOT** use the hoist load limiting or warning device to measure load.
- **NOT** operate except with manual power
- **NOT** permit more than one operator to pull on a single hand chain at the same time. More than one operator is likely to cause hoist overload.

2.0 Technical Information

2.1 Specifications

2.1.1 Operating Conditions and Environment:

Temperature Range: -40° to +140°F
(-40° to +60°C)

Humidity: 100% or less
This is not underwater device.

Material: No special materials such as spark resistant and asbestos.

Do Not Use: In an alkaline/acidic or an organic solvent/explosive atmosphere.

2.1.2 Hoist Specifications:

Product Code	CX003	
Capacity (Ton)	1/4	
Headroom C (in.)	8.5	
Standard Lift (ft)	8, 10 or 20	
Pull to Lift Rated Load (lbs)	33	
Overhaul Ratio	34	
Load Chain Dia. x Pitch (mm)	3.2 x 9.0	
Chain Fall Lines	1	
Net Weight (lbs)	8 ft Lift	5.3
	10 ft Lift	5.6
	20 ft Lift	9.5

2.1.3 Hoist Parts

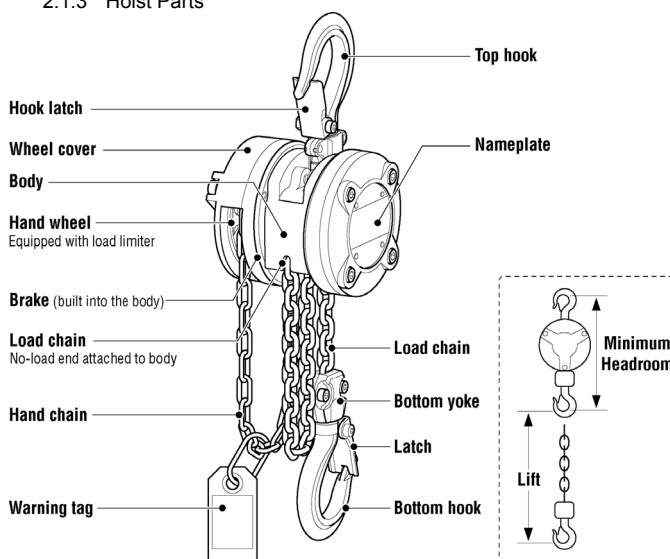

3.0 Preoperational Procedures

3.1 Mounting Location

3.1.1 **⚠WARNING** Prior to mounting the hoist ensure that the suspension and the supporting structure are adequate to support the hoist and its loads. If necessary consult a professional that is qualified to evaluate the adequacy of the suspension location and its supporting structure. The maximum force which can be applied to the supporting structure is 2.4 times the rated capacity.

3.2 Mounting the Hoist

3.2.1 Manual Trolley – Follow instructions in Owner's Manual provided with the trolley.

3.2.2 Hook Mounted to a Fixed Location - Attach the hoist's top hook to the fixed suspension point.

3.2.3 **⚠WARNING** Ensure that the fixed suspension point rests on the center of the hook's saddle and that the hook's latch is engaged.

3.3 Preoperational Checks and Trial Operations

3.3.1 **⚠WARNING** Confirm the adequacy of the rated capacity for all slings, chains, wire ropes and all other lifting attachments before use. Inspect all load suspension members for damage prior to use and replace or repair all damaged parts.

3.3.2 Measure and record the "k" dimension of the top and bottom hook. See Table 5-4 under Section 5.0, "Inspection".

3.3.3 Record the hoist's Code, Lot and Serial Number (from the name plate on the hoist; see Section 2.1.4) in the space provided on the cover of this manual.

3.3.4 Ensure that the hoist is properly installed to a fixed point.

3.3.5 Ensure that all nuts and bolts are sufficiently fastened.

3.3.6 Confirm proper operation:

- Before operating read and become familiar with Section 4 - Operation.
- Before operating ensure that the hoist meets the Inspection, Testing and Maintenance requirements of ANSI/ASME B30.16.
- Before operating ensure that nothing will interfere with the full range of the hoist's operation.

4.0 Operation

4.1 Introduction

- 4.1.1 **▲WARNING** HOIST OPERATORS SHALL BE REQUIRED TO READ THE OPERATION SECTION OF THIS MANUAL, THE WARNINGS CONTAINED IN THIS MANUAL, INSTRUCTION AND WARNING LABELS ON THE HOIST OR LIFTING SYSTEM, AND THE OPERATION SECTIONS OF ANSI/ASME B30.16 and ANSI/ASME B30.10.

4.2 Lifting and Lowering

- 4.2.1 Refer to the arrows and text on the hand wheel cover – see Figure 4-1.
- 4.2.2 To **LIFT** the Load – When facing the hand wheel side of the hoist, pull down on the **RIGHT** side hand chain.
- 4.2.3 To **LOWER** the Load – When facing the hand wheel side of the hoist, pull down on the **LEFT** side hand chain.
- 4.2.4 **▲WARNING** This product is designed for a rated load to be hoisted by pulling the hand chain with a force of 33 lb (15kg) or less. Do NOT pull on the hand chain with a force greater than 33 lb (15kgf). Stop using the hoist and consult a qualified person if the a load of 1/4 Ton or less cannot be lifted with a pull force of 33 lb (15kgf) or less.

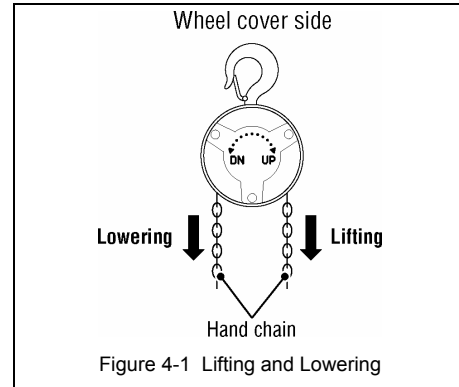

5.0 Inspection

- 5.1 **Initial Inspection** – Prior to initial use, all new, altered, or modified hoists shall be inspected by a designated person to ensure compliance with the applicable provisions of this manual.
- 5.2 **Inspection Classification** – The inspection procedure herein is based on ANSI/ASME B30.16. Inspections for hoists in regular service are divided into FREQUENT and PERIODIC groups based upon the intervals at which inspection should be performed. The intervals in turn are dependent upon the degree of service and usage the hoists are subjected to. The two general classifications are herein designated as FREQUENT and PERIODIC, with respective intervals between inspections as defined in Table 4-1.

Service	FREQUENT Inspection	PERIODIC Inspection
Normal Service	Monthly	Yearly
Heavy Service	Weekly to Monthly	Semiannually
Severe Service	Daily to Weekly	Quarterly
Special or Infrequent Service	As recommended by a qualified person before and after each occurrence.	As recommended by a qualified person before the first such occurrence and as directed by the qualified person for any subsequent occurrences.

5.3 Frequent Inspection

- 5.3.1 Inspections should be made on a FREQUENT basis in accordance with Table 5-2, "Frequent Inspection." Included in these FREQUENT Inspections are observations made during operation for any defects or damage that might appear between Periodic Inspections. Evaluation and resolution of the results of FREQUENT Inspections shall be made by a designated person such that the hoist is maintained in safe working condition.

All functional operating mechanisms for proper operation and adjustment, maladjustment and unusual sounds.
Hoist braking system for proper operation
Hooks and latches in accordance with ANSI/ASME B30.10
Hook latch operation
Load chain in accordance with Section 5.5
Hoist support for damage

5.4 Periodic Inspection

- 5.4.1 Inspections should be made on a PERIODIC basis in accordance with Table 5-3, "Periodic Inspection." Evaluation and resolution of the results of PERIODIC Inspections shall be made by a designated person such that the hoist is maintained in safe working condition.
- 5.4.2 For inspections where load suspension parts of the hoist are disassembled, a load test per ANSI/ASME B30.16 must be performed on the hoist after it is re-assembled and prior to its return to service.

Table 5-3 Periodic Inspection
Requirements of frequent inspection.
Evidence of loose bolts, nuts, or rivets.
Evidence of worn, corroded, cracked, or distorted parts such as suspension housing, chain attachments, yokes, suspension bolts, shafts, gears, bearings, pins, rollers and locking and clamping devices.
Evidence of damage to hook retaining nuts or collars and pins, and welds or rivets used to secure the retaining members.
Evidence of damage or excessive wear of load sheave.
Evidence of worn, glazed or oil contaminated friction disks; worn pawls, cams or ratchet; corroded, stretched, or broken pawl springs in brake mechanism.
Evidence of damage to supporting structure.
Function label on hoist for legibility.
Warning label properly attached to the hoist and legible (see Section 8.0, Fig. No. 33).
End connections of load chain stopper link.

5.5 Inspection Methods and Criteria

- 5.5.1 This section covers the inspection of specific items. The list of items in this section is based on those listed in ANSI/ASME B30.16 for the Frequent and Periodic Inspection.
- 5.5.2 Frequent Inspection - Not intended to involve disassembly of the hoist. Disassembly for further inspection would be required if only if frequent inspection results so indicate. Disassembly and further inspection should only be performed by a qualified person trained in the disassembly and re-assembly of the hoist.
- 5.5.3 Periodic Inspection - Disassembly of the hoist is required. Disassembly should only be performed by a qualified person trained in the disassembly and re-assembly of the hoist.

Table 5-4 Hoist Inspection Methods and Criteria			
Item	Method	Criteria	Action
Functional operating mechanisms.	Visual, Auditory	Mechanisms should be properly adjusted and should not produce unusual sounds when operated. Components should not be deformed, scarred or show significant wear.	Repair or replace as required.
Braking System – Components	Visual	Brake Pawl, Pawl Shaft, Pawl Spring, Friction Disc and Ratchet Disc should not be deformed scarred or show significant wear.	Replace
Braking System – Friction Plate	Visual, Measure	The surface of the friction plate should be free of grease, oil, scars, gouges and wear and have uniform thickness. The thickness of both plates together should not be less than the discard value listed in Table 5-7.	Replace
Housing Mechanical and Lifting System – Components	Visual, Auditory, Function	Hoist components including load blocks, suspension housing, chain attachments, clevises, yokes, suspension bolts, shafts, gears, bearings, pins and rollers should be free of cracks, distortion, significant wear and corrosion. Evidence of same can be detected visually or via detection of unusual sounds during operation.	Replace.
Hooks – Condition	Visual	Should be free of gouges, dents, weld splatter, significant corrosion, twists, deformations, significant wear, dirt and grime. Hook should swivel freely.	Replace.
Hooks – Fretting wear	Measure	The "u" and "t" dimensions should not be less than the discard value listed in Table 5-5.	Replace.
Hooks – Stretch	Measure	The "k" dimension should not be greater than 1.05 times that measured and recorded at the time of purchase (See Section 3.1). If recorded "k" values are not available for hooks when new, use nominal "k" values from Table 5-5.	Replace.
Hooks – Hook Latches	Visual, Function	Latch should not be deformed. Attachment of latch to hook should not be loose or stiff. Latch spring should not be missing and should not be weak.	Replace.
Hooks – Yoke Assembly	Visual	Should be free of significant rust, weld splatter, nicks, and gouges. Holes should not be elongated, fasteners should not be loose (Refer to figure in Section 8.0), and there should be no gap between mating parts.	Torque or replace as required.
Yoke – Hole Deformation	Visual, Measure	The "D" dimension of the top pin hole should not be greater than the discard value listed in Table 5-8.	Replace Hook Set
Top Pin – Deformation	Visual, Measure	The top pin should be free of scars or significant deformation. The "E" dimension should not be less than discard value listed in Table 5-9.	Replace
Load Chain – Surface Condition, Lubrication	Visual	Should be free of gouges, nicks, dents, weld splatter and corrosion. Links should not be deformed, and should not show signs of abrasion. Surfaces where links bear on one another should be free of significant wear. Entire surface should be coated with lubricant and should be free of dirt and grime.	Replace (only with load chain listed in parts list).
Load Chain – Pitch and Wire Diameter	Measure	The "P" dimension should not be greater than discard value listed in Table 5-6. The "d" dimension should not be less than discard value listed in Table 5-6.	Replace (see above). Inspect load sheave.
Bolts, Nuts and Rivets	Visual, Check with Proper Tool	Bolts, nuts and rivets should not be loose, deformed or corroded.	Tighten or replace as required.

Item	Method	Criteria	Action
Load Sheave	Visual	Pockets of Load Sheave should be clean and free of significant wear.	Replace.
Warning Labels	Visual	Warning Labels should be affixed to the hoist and they should be legible. (see Section 8.0, Figure Number 33)	Replace.
Hoist Capacity Label	Visual	The label that indicates the capacity of the hoist should be legible and securely attached to the hoist.	Replace.

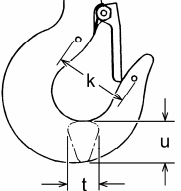
"k" Measured When New: Top: _____ Bottom: _____		Product Code	Nominal "k" Dimension* inch (mm)	"u" Dimension inch (mm)		"t" Dimension inch (mm)	
				Standard	Discard	Standard	Discard
		CX003	1.35 (34.4)	0.49 (12.5)	0.47 (11.9)	0.43 (11.0)	0.41 (10.5)

* These values are nominal since the dimension is not controlled to a tolerance. The "k" dimension should be measured when the hook is new - this becomes a reference measurement. Subsequent measurements are compared to this reference to make determinations about hook deformation/stretch. See Section 5-5, "Hooks - Stretch".

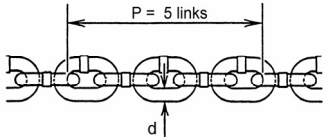
	Product Code	"P" inch (mm)		"d" inch (mm)	
		Standard	Discard	Standard	Discard
	CX003	1.79 (45.5)	1.84 (46.8)	0.126 (3.2)	0.11 (2.9)

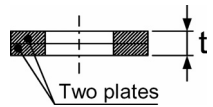
	Product Code	Standard inch (mm)	Discard inch (mm)
		CX003	0.20 (5.0)

	Product Code	Standard inch (mm)	Discard inch (mm)
		CX003	0.33 (8.3)

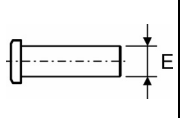
	Product Code	Standard inch (mm)	Discard inch (mm)
		CX003	0.33 (8.3)

6.0 Maintenance

6.1 For hoist maintenance or storage, comply with the following points.

6.1.1 **⚠ DANGER** Do not lubricate the friction plate of the mechanical brake.

6.1.2 **⚠ CAUTION**

- Always ensure that lubricant is applied to the load chain, the top pin, the hook necks, the hook latches and the select lever. Refer to Section 2.1.4 "Hoist Parts".
- Do not store the hoist under a load.
- Remove any dirt or water on the hoist.
- Store the hoist in a dry and clean area.

- Possibility of corrosion on components of the hoist increases for installations where salt air and high humidity are present. Make frequent and regular inspections of the hoist's condition and operation.
- Perform all inspections given in "5.0 Inspection" if irregularity of the hoist is found after operation

6.2 Disassembly/Assembly

6.2.1 When re-assembling the hoist, refer to parts list figure in Section 8.0 for the proper component placement and orientation.

6.2.2 **⚠ CAUTION** Load Limiter – Do NOT attempt to disassemble or adjust the Load Limiter built into the Hand Wheel Assembly. Replace the Hand wheel as an assembly with a new, factory adjusted part

6.2.3 Gear timing – Installing the Gear #2's with the timing marks "O" oriented as shown in Figure 6-1.

6.2.4 **⚠ WARNING** Make certain the no-load end Load Chain is not twisted when attached to the hoist body. See Section 2-1-4 for attachment point.

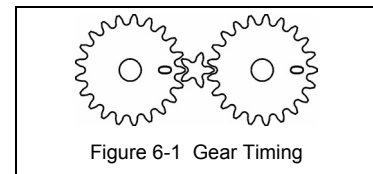

7.0 Warranty

All products sold by Harrington Hoists, Inc. are warranted to be free from defects in material and workmanship from date of shipment by Harrington for the following periods:

Manual Hoists & Trolleys - 2 years
Air and Electric Powered Hoists, Trolleys, and Crane Components - 1 year
Spare / Replacement Parts - 1 year

The product must be used in accordance with manufacturer's recommendations and must not have been subject to abuse, lack of maintenance, misuse, negligence, or unauthorized repairs or alterations.

Should any defect in material or workmanship occur during the above time period in any product, as determined by Harrington Hoist's inspection of the product, Harrington Hoists, Inc. agrees, at its discretion, either to replace (not including installation) or repair the part or product free of charge and deliver said item F.O.B. Harrington Hoists, Inc. place of business to customer.

Customer must obtain a Return Goods Authorization as directed by Harrington or Harrington's published repair center prior to shipping product for warranty evaluation. An explanation of the complaint must accompany the product. Product must be returned freight prepaid. Upon repair, the product will be covered for the remainder of the original warranty period. If it is determined there is no defect, or that the defect resulted from causes not within the scope of Harrington's warranty, the customer will be responsible for the costs of returning the product.

Harrington Hoists, Inc. disclaims any and all other warranties of any kind expressed or implied as to the product's merchantability or fitness for a particular application. Harrington will not be liable for death, injuries to persons or property or for incidental, contingent, special or consequential damages, loss or expense arising in connection with the use or inability whatever, regardless of whether damage, loss or expense results from any act or failure to act by Harrington, whether negligent or willful, or from any other reason.

8.0 Parts List

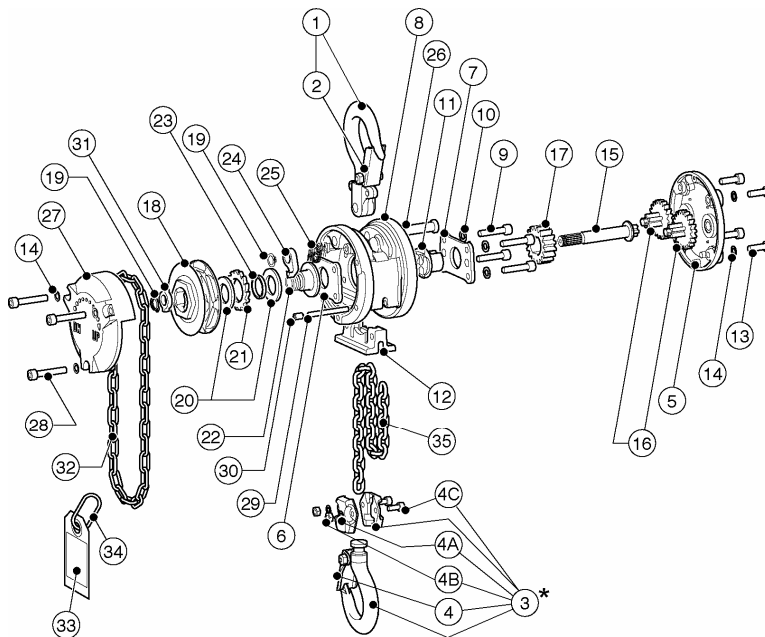

* Bottom Hook Fasteners:
 - Torque to 40 – 48 lb_f-in.
 - Use Loctite®
 Threadlocker 241 or 242.

Figure No.	Part Name	Parts Per Hoist	Part Number
1	Top Hook Assembly	1	L1XA0031001
2	Latch Assembly	1	L1XA0031071
3 *	Bottom Hook Assembly	1	L1XA0031021
4	Latch Assembly	1	L1XA0031071
4A	Spring Lock Washer	2	9012707
4B	Hex Nut	2	9093414
4C	Socket Head Cap Screw	2	9091203
5	Gear Case Assembly with Nameplate	1	C1XU0035103
6	Frame A	1	C1XA0039101
7	Frame B	1	C1XA0039102
8	Body Assembly	1	C1XA0036104
9	Socket Head Cap Screw	4	9091330
10	Spring Lock Washer	4	9798003
11	Load Sheave	1	C1XA0039116

Figure No.	Part Name	Parts Per Hoist	Part Number
12	Chain Guide	1	C1XA0039162
13	Socket Head Cap Screw	4	9091328
14	Conical Lock Washer	7	C1XA0039109
15	Pinion	1	C1XA0039111
16	Gear #2	2	C1XA0039112
17	Load Gear	1	C1XA0039114
18	Hand Wheel Assembly w/Load Limiter	1	C1XA0035115
19	Snap Ring	2	9047109
20	Friction Plate	2	C1XA0039151
21	Ratchet Disc	1	C1XA0039152
22	Friction Disc	1	C1XA0039153
23	Bushing	1	C1XA0039154
24	Pawl	1	C1XA0039155

Figure No.	Part Name	Parts Per Hoist	Part Number
25	Pawl Spring Assy (2 springs)	1	C1XA0031158
26	Top Pin	1	C1XA0039163
27	Wheel Cover	1	C1XA0039171
28	Socket Head Cap Screw	3	9091331
29	End Pin	1	C1XA0039177
30	Hexagon Socket Set Screw	1	J1TB01105008
31	Cam Guide	1	C1XA0039203
32 **	Hand Chain - For 8 or 10 Ft Lift	1	6085301
	Hand Chain - For 20 Ft Lift	1	6085302
33	Warning Tag	1	WTAG9
34	Chain Stopper Link	1	L5BA0089045
35	Load Chain	FT	LCLX003NP

** Other hand chain lengths available – consult Harrington customer service.

Harrington Hoists, Inc.
 401 West End Avenue
 Manheim, PA 17545-1703
 Phone: 717-665-2000
 Toll Free: 800-233-3010
 Fax: 717-665-2861

HARRINGTON
 HOISTS AND CRANES

www.harringtonhoists.com

Harrington Hoists - Western Division
 2341 Pomona Rincon Rd. #103
 Corona, CA 91720-6973
 Phone: 951-279-7100
 Toll Free: 800-317-7111
 Fax: 951-279-7500

CXOM