

ROLLER

Gravity Roller Curve Conveyor
 (2 1/2 in. Dia. x 11 Ga. Rollers)
 (2 5/8 in. Dia. x 7 Ga. Rollers)

Heavy-duty gravity roller curve conveyors add versatility to straight gravity roller conveyors. Curves are supplied with 2 1/2 in. dia. rollers mounted in a powder painted steel channel. Curves may be furnished with rollers set high, or with rollers set low to form 3/4 in. high guard rails.

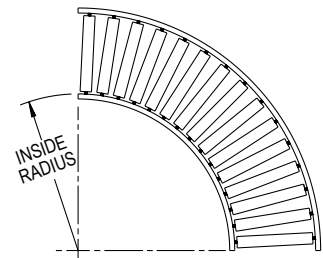

OAW	BR	Inside Radius	Rollers Per Curve 90°	Model No. 25SRC 2 1/2" Rollers	Weight (Lbs) 90°	Model No. 26SRC 2 5/8" Rollers	Weight (Lbs) 90°
16 1/4"	13"	32 1/2"	16 Single	25SRC-13-90S	170	26SRC-13-90S	196
18 1/4"	15"			25SRC-15-90S	185	26SRC-15-90S	216
20 1/4"	17"			25SRC-17-90S	200	26SRC-17-90S	235
22 1/4"	19"			25SRC-19-90S	212	26SRC-19-90S	252
24 1/4"	21"			25SRC-21-90S	230	26SRC-21-90S	274
26 1/4"	23"			25SRC-23-90S	245	26SRC-23-90S	294
28 1/4"	25"			25SRC-25-90S	260	26SRC-25-90S	313
30 1/4"	27"			25SRC-27-90S	276	26SRC-27-90S	333
34 1/4"	31"	48"	37 Double	25SRC-31-90D	432	26SRC-31-90D	505
36 1/4"	33"			25SRC-33-90D	451	26SRC-33-90D	530
40 1/4"	37"			25SRC-37-90D	589	26SRC-37-90D	578
42 1/4"	39"			25SRC-39-90D	508	26SRC-39-90D	602
46 1/4"	43"			25SRC-43-90D	546	26SRC-43-90D	650
50 1/4"	47"			25SRC-47-90D	583	26SRC-47-90D	697
54 1/4"	51"			25SRC-51-90D	622	26SRC-51-90D	746

OAW	BR	Inside Radius	Rollers Per Curve 45°	Model No. 25SRC 2 1/2" Rollers	Weight (Lbs) 45°	Model No. 26SRC 2 5/8" Rollers	Weight (Lbs) 45°
16 1/4"	13"	32 1/2"	8 Single	25SRC-13-45S	91	26SRC-13-45S	104
18 1/4"	15"			25SRC-15-45S	98	26SRC-15-45S	113
20 1/4"	17"			25SRC-17-45S	106	26SRC-17-45S	123
22 1/4"	19"			25SRC-19-45S	113	26SRC-19-45S	133
24 1/4"	21"			25SRC-21-45S	121	26SRC-21-45S	143
26 1/4"	23"			25SRC-23-45S	128	26SRC-23-45S	152
28 1/4"	25"			25SRC-25-45S	136	26SRC-25-45S	162
30 1/4"	27"			25SRC-27-45S	143	26SRC-27-45S	172
34 1/4"	31"	48"	19 Double	25SRC-31-45D	311	26SRC-31-45D	349
36 1/4"	33"			25SRC-33-45D	323	26SRC-33-45D	363
40 1/4"	37"			25SRC-37-45D	348	26SRC-37-45D	393
42 1/4"	39"			25SRC-39-45D	360	26SRC-39-45D	408
46 1/4"	43"			25SRC-43-45D	385	26SRC-39-45D	438
50 1/4"	47"			25SRC-47-45D	408	26SRC-47-45D	467
54 1/4"	51"			25SRC-51-45D	434	26SRC-51-45D	498

OAW	BR	Inside Radius	Rollers Per Curve 60°	Model No. 25SRC 2 1/2" Rollers	Weight (Lbs) 60°	Model No. 26SRC 2 5/8" Rollers	Weight (Lbs) 60°
16 1/4"	13"	32 1/2"	10 Single	25SRC-13-60S	128	26SRC-13-60S	147
18 1/4"	15"			25SRC-15-60S	138	26SRC-15-60S	162
20 1/4"	17"			25SRC-17-60S	150	26SRC-17-60S	177
22 1/4"	19"			25SRC-19-60S	159	26SRC-19-60S	189
24 1/4"	21"			25SRC-21-60S	173	26SRC-21-60S	205
26 1/4"	23"			25SRC-23-60S	183	26SRC-23-60S	221
28 1/4"	25"			25SRC-25-60S	195	26SRC-25-60S	235
30 1/4"	27"			25SRC-27-60S	207	26SRC-27-60S	250
34 1/4"	31"	48"	23 Double	25SRC-31-60D	324	26SRC-31-60D	378
36 1/4"	33"			25SRC-33-60D	339	26SRC-33-60D	398
40 1/4"	37"			25SRC-37-60D	366	26SRC-37-60D	433
42 1/4"	39"			25SRC-39-60D	381	26SRC-39-60D	451
46 1/4"	43"			25SRC-43-60D	410	26SRC-43-60D	488
50 1/4"	47"			25SRC-47-60D	438	26SRC-47-60D	523
54 1/4"	51"			25SRC-51-60D	467	26SRC-51-60D	559

OAW	BR	Inside Radius	Rollers Per Curve 30°	Model No. 25SRC 2 1/2" Rollers	Weight (Lbs) 30°	Model No. 26SRC 2 5/8" Rollers	Weight (Lbs) 30°
16 1/4"	13"	32 1/2"	5 Single	25SRC-13-30S	57	26SRC-13-30S	65
18 1/4"	15"			25SRC-15-30S	61	26SRC-15-30S	72
20 1/4"	17"			25SRC-17-30S	66	26SRC-17-30S	78
22 1/4"	19"			25SRC-19-30S	70	26SRC-19-30S	84
24 1/4"	21"			25SRC-21-30S	75	26SRC-21-30S	91
26 1/4"	23"			25SRC-23-30S	81	26SRC-23-30S	97
28 1/4"	25"			25SRC-25-30S	86	26SRC-25-30S	103
30 1/4"	27"			25SRC-27-30S	91	26SRC-27-30S	110
34 1/4"	31"	48"	13 Double	25SRC-31-30D	143	26SRC-31-30D	167
36 1/4"	33"			25SRC-33-30D	148	26SRC-33-30D	175
40 1/4"	37"			25SRC-37-30D	161	26SRC-37-30D	191
42 1/4"	39"			25SRC-39-30D	167	26SRC-39-30D	198
46 1/4"	43"			25SRC-43-30D	181	26SRC-43-30D	215
50 1/4"	47"			25SRC-47-30D	192	26SRC-47-30D	230
54 1/4"	51"			25SRC-51-30D	205	26SRC-51-30D	246

• STANDARD SPECIFICATIONS

WIDTHS—Between Rail Width 13 in., 15 in., 17 in., 19 in., 21 in., 23 in., 25 in., 27 in., 31 in., 33 in., 37 in., and 39 in., 43 in., 47 in., & 51 in.

FRAME—4 in. deep x 1 1/8 in. flange x 4 ga. powder painted formed steel channel with bolt-in cross members set high, welded cross members set low.

BUTT COUPLINGS—For bolting sections together.

CURVES—30°, 45°, 60° and 90° with 32 1/2 in. inside radius up to 27 in., 48 in. inside radius on 31 in. to 51 in. between rail widths.

ROLLERS—25-SRC 2 1/2 in. dia. x 11 ga. steel tubing. Bearings are labyrinth sealed and grease packed.

AXLES—1 1/8 in. hex shaft, spring loaded.

CAPACITY—Same per foot capacity as straight sections. See charts previous page.

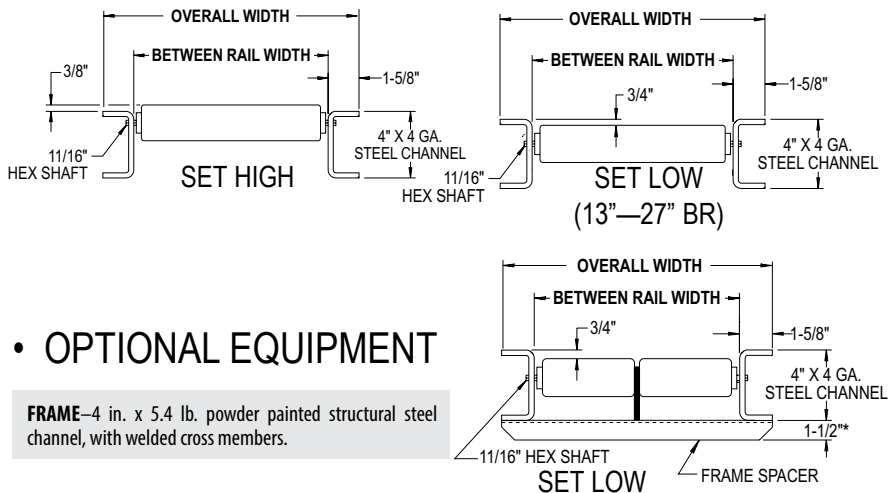

• OPTIONAL EQUIPMENT

FRAME—4 in. x 5.4 lb. powder painted structural steel channel, with welded cross members.

*Frame spacer 1 1/2" below channel on 31" to 51" BR only.

