



**SPIDER<sup>®</sup>**  
SHELVING SYSTEM

## THE MOST VERSATILE SHELVING SYSTEM THAT EXISTS

### *Much more than a simple shelving unit!*

Sturdy construction and quick assembly, the Spider<sup>®</sup> shelving system meets all of your storage needs. With its vast range of accessories, it offers the most diverse options on the market, making finding solutions for all your storage problems as easy as 1, 2, 3.

- The combination of shelving and Mini-Racking opens up a whole new avenue of possibilities;
- Adding modular drawers guarantees you secure organization of all your small parts;
- Vertical expansion is also a possibility thanks to our multi-level shelving system.

Designed for intensive use, our modular storage system will maximize the space in your warehouse, parts department, maintenance workshop, distribution center, etc.

Our expertise ensures you peace of mind for all of your needs, present and future!



R5XEC-2004

# Spider® Shelving System

## The Rousseau Advantages

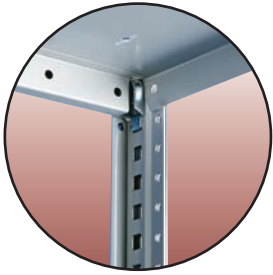

Assembly is simple : shelves are installed on the posts using 4 compression clips, in 14 gauge steel. This makes for easy and fast adjustments.

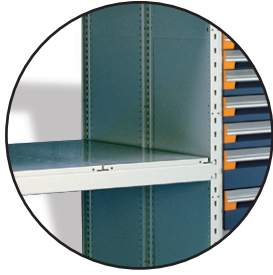

Mini-Racking integrated into your shelving optimizes your storage possibilities.

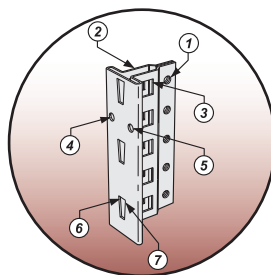

A unique and super functional post. The common post is the cornerstone of the structure. Its unique T-shape offers up to 7 fixing zones for different applications. Plus, its hollow center makes for installations without interference.

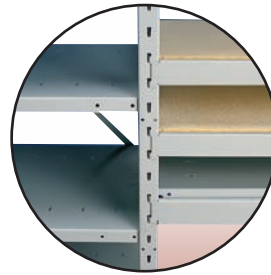

The steel beams are designed for several types of decking : wood, steel and wire. Two types of beams are available, depending on the load capacity and dimensions required. Load capacity can reach 1925 lb.



Each component is designed to offer you an easy-to-use product.

## General Dimensions

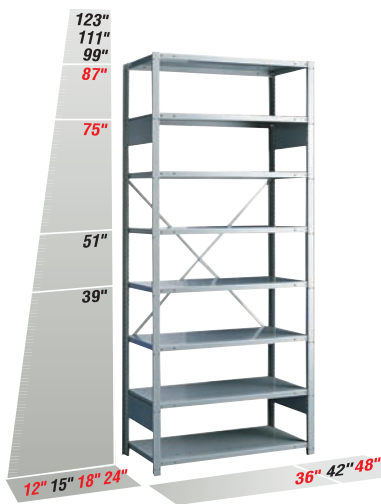

SHE1024  
Popular dimensions shown in red.



SRE5127S

Index	Page(s)
<b>Spider® Shelving System</b>	52 - 53
<b>Industrial Shelving</b>	
Proposals	54 - 58
Accessories	59 - 64
Components	65 - 67
<b>Mini-Racking</b>	
Proposals	68 - 69
Accessories	70
Components	71 - 73

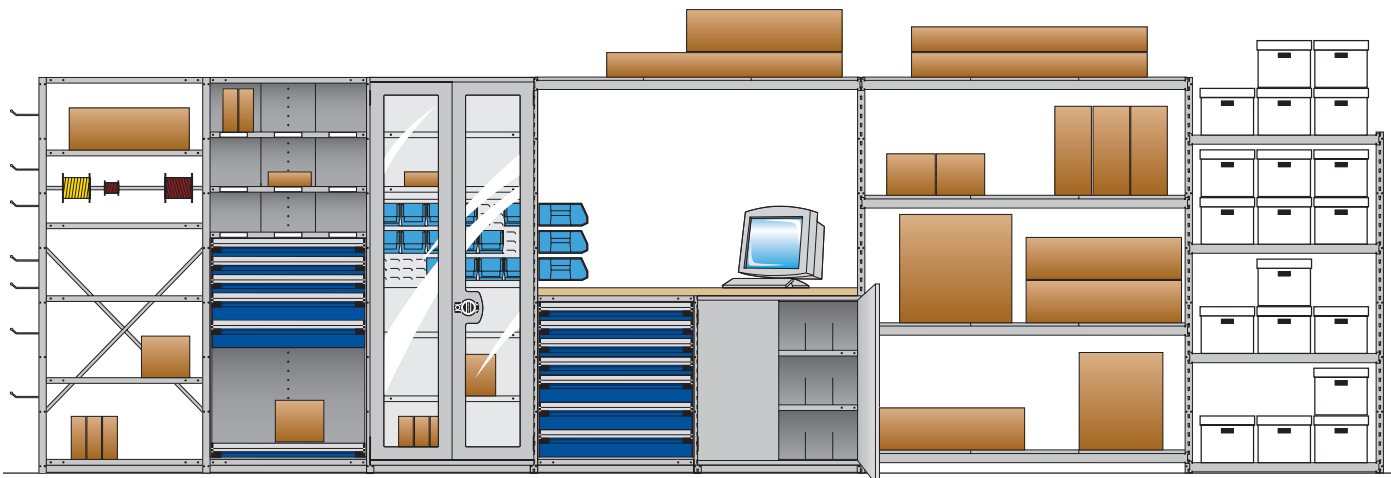



SHE1024



SHE2024

**When ordering, model numbers must be completed as follows:**



**H** for posts with smooth finish surface  
**R** for posts with perforated surface

	Starter Unit	Add-on Unit
<b>BOLTED uprights</b>	<b>D</b>	<b>A</b>
<b>WELDED uprights</b>	<b>E</b>	<b>B</b>

Example : S H D 1 0 0 1

For a model with smooth finish posts and bolted open uprights

EXAMPLE: S **1** **001**

**1** for open shelving  
**2** for closed shelving

## Open and Closed Shelving : 36", 42" and 48" Wide

### Open Shelving

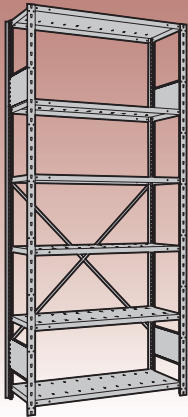

SRE1011  
Starter

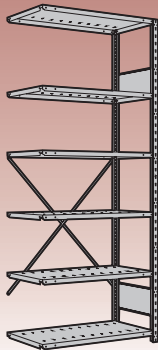

SRB1011  
Add-on

Shown here are several of the more popular shelving models.

Proposals include open or closed uprights and BOX shelves;

Closed shelving proposals include back panels and front base;

Open shelving proposals include one back brace.

W	Dimensions		Number of Shelves				
	D	H	5	6	7	8	
36"	12"	75"	S__001	S__007	S__013	S__019	
		18"	S__002	S__008	S__014	S__020	
		24"	S__003	S__009	S__015	S__021	
	18"	77"	S__004	S__010	S__016	S__022	
		18"	S__005	S__011	S__017	S__023	
		24"	S__006	S__012	S__018	S__024	
	24"	99"	S__401	S__407	S__413	S__419	
		18"	S__402	S__408	S__414	S__420	
		24"	S__403	S__409	S__415	S__421	
42"	12"	75"	S__131	S__137	S__143	S__149	
		18"	S__132	S__138	S__144	S__150	
		24"	S__133	S__139	S__145	S__151	
	18"	77"	S__134	S__140	S__146	S__152	
		18"	S__135	S__141	S__147	S__153	
		24"	S__136	S__142	S__148	S__154	
	24"	99"	S__531	S__537	S__543	S__549	
		18"	S__532	S__538	S__544	S__550	
		24"	S__533	S__539	S__545	S__551	
	48"	12"	75"	S__031	S__037	S__043	S__049
			18"	S__032	S__038	S__044	S__050
			24"	S__033	S__039	S__045	S__051
18"		77"	S__034	S__040	S__046	S__052	
		18"	S__035	S__041	S__047	S__053	
		24"	S__036	S__042	S__048	S__054	
24"		99"	S__431	S__437	S__443	S__449	
		18"	S__432	S__438	S__444	S__450	
		24"	S__433	S__439	S__445	S__451	

### Closed Shelving

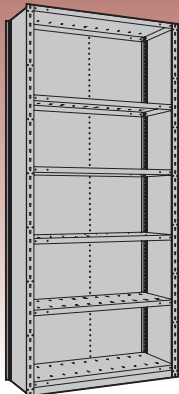

SRE2011  
Starter

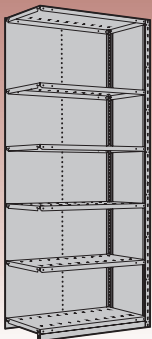

SRB2011  
Add-on

# Industrial Shelving Proposals

Back-to-Back Open and Closed Shelving : 36", 42" and 48" Wide

## Open Shelving

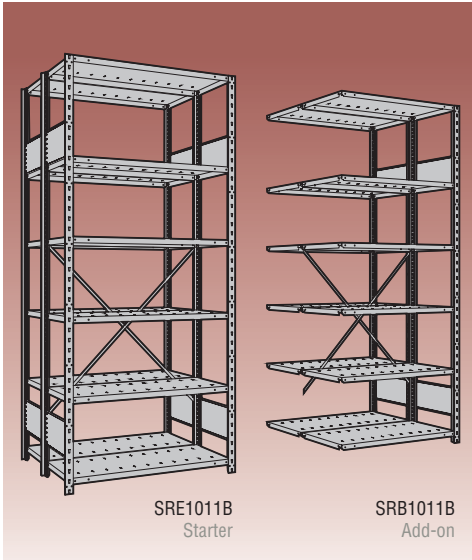

SRE1011B  
Starter

SRB1011B  
Add-on

Shown here are several of the more popular shelving models.

Proposals include open or closed uprights and BOX shelves;

Closed shelving proposals include back panels and front base;

Open shelving proposals include one back brace.

Dimensions			Number of Shelves				
W	D	H	10	12	14	16	
36"	24"	75"	S__001B	S__007B	S__013B	S__019B	
			S__002B	S__008B	S__014B	S__020B	
			S__003B	S__009B	S__015B	S__021B	
	24"	87"	S__004B	S__010B	S__016B	S__022B	
			S__005B	S__011B	S__017B	S__023B	
			S__006B	S__012B	S__018B	S__024B	
	24"	99"	S__401B	S__407B	S__413B	S__419B	
			S__402B	S__408B	S__414B	S__420B	
			S__403B	S__409B	S__415B	S__421B	
	42"	24"	75"	S__131B	S__137B	S__143B	S__149B
				S__132B	S__138B	S__144B	S__150B
				S__133B	S__139B	S__145B	S__151B
24"		87"	S__134B	S__140B	S__146B	S__152B	
			S__135B	S__141B	S__147B	S__153B	
			S__136B	S__142B	S__148B	S__154B	
24"		99"	S__531B	S__537B	S__543B	S__549B	
			S__532B	S__538B	S__544B	S__550B	
			S__533B	S__539B	S__545B	S__551B	
48"		24"	75"	S__031B	S__037B	S__043B	S__049B
				S__032B	S__038B	S__044B	S__050B
				S__033B	S__039B	S__045B	S__051B
	24"	87"	S__034B	S__040B	S__046B	S__052B	
			S__035B	S__041B	S__047B	S__053B	
			S__036B	S__042B	S__048B	S__054B	
	24"	99"	S__431B	S__437B	S__443B	S__449B	
			S__432B	S__438B	S__444B	S__450B	
			S__433B	S__439B	S__445B	S__451B	

## Closed Shelving

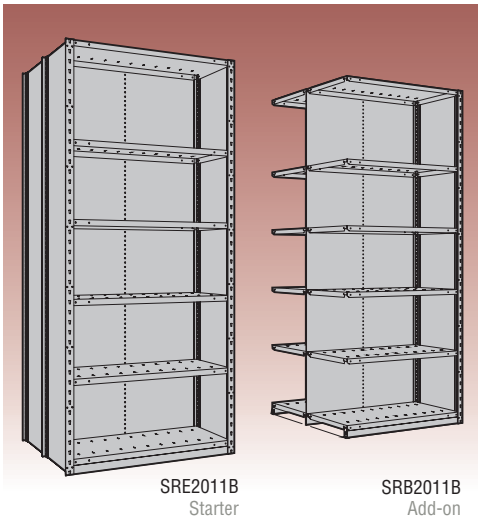

SRE2011B  
Starter

SRB2011B  
Add-on



SPIDER®  
SHELVING SYSTEM

## 87" High Closed Shelving with Accessories

Shown here are several of the most popular shelving models. **NOTE** To complete product #.

SEE PAGE 54

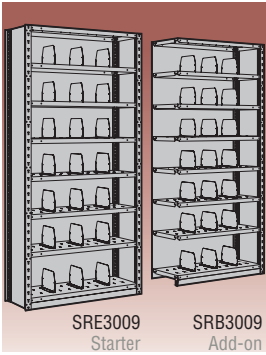

### Shelving with Dividers

- 8 shelves
- 28 openings :  
- 28 op. 12" x 9"
- 21 dividers, 5 1/2" high

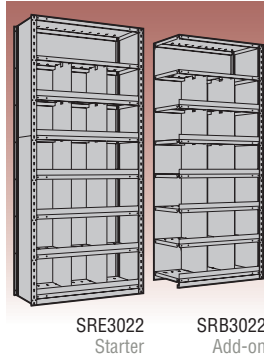

### Shelving with Dividers

- 8 shelves
- 19 openings :  
- 18 op. 12" x 12"  
- 1 op. 36" x 12"
- 12 dividers, 12" high
- 6 shelf fronts

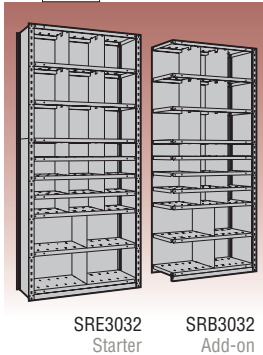

### Shelving with Dividers

- 10 shelves
- 25 openings :  
- 9 op. 12" x 12"  
- 12 op. 12" x 6"  
- 4 op. 18" x 12"
- 8 dividers, 6" high
- 8 dividers, 12" high

Product #	W x D
S_ 3008	36" x 12"
S_ 3009	36" x 18"
S_ 3010	36" x 24"

Product #	W x D
S_ 3021	36" x 12"
S_ 3022	36" x 18"
S_ 3023	36" x 24"

Product #	W x D
S_ 3031	36" x 12"
S_ 3032	36" x 18"
S_ 3033	36" x 24"

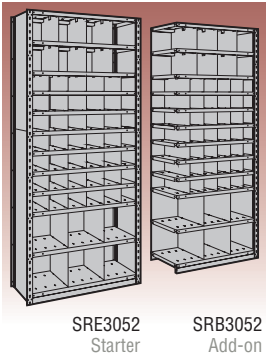

### Shelving with Dividers

- 12 shelves
- 56 openings :  
- 8 op. 9" x 9"  
- 42 op. 6" x 6"  
- 6 op. 12" x 12"
- 35 dividers, 6" high
- 6 dividers, 9" high
- 4 dividers, 12" high

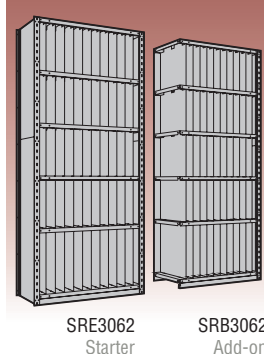

### Shelving with Dividers for X-ray Files

- 6 shelves
- 60 openings :  
- 48 op. 3" x 16"  
- 12 op. 3" x 20"
- 44 dividers, 16" high
- 11 dividers, 20" high

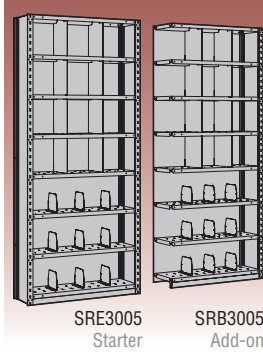

### Shelving with Dividers

- 8 shelves
- 8 dividers, 12" high
- 9 dividers, 5 1/2" high

Product #	W x D
S_ 3051	36" x 12"
S_ 3052	36" x 18"
S_ 3053	36" x 24"

Product #	W x D
S_ 3062	36" x 18"

Product #	W x D
S_ 3004	36" x 12"
S_ 3005	36" x 18"
S_ 3006	36" x 24"

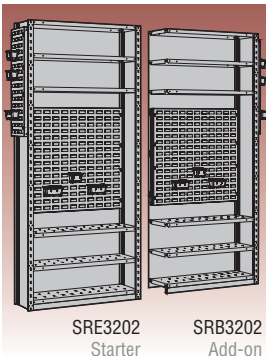

### Shelving with Accessories

- 6 shelves
- 2 louvered panels
- 6 plastic bins

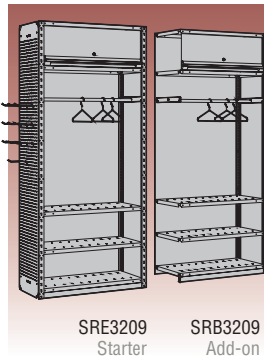

### Shelving with Accessories

- 5 shelves
- 1 flipper door
- 1 clothes hanging rail
- 1 perforated panel
- 10 hooks

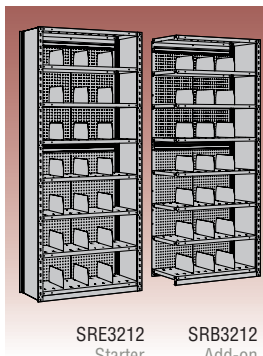

### Shelving with Accessories

- 8 shelves
- 21 dividers, 5 1/2" high
- perforated back panel
- 10 hooks

Product #	W x D
S_ 3201	36" x 12"
S_ 3202	36" x 18"
S_ 3203	36" x 24"

Product #	W x D
S_ 3209	36" x 18"
S_ 3210	36" x 24"

Product #	W x D
S_ 3211	36" x 12"
S_ 3212	36" x 18"
S_ 3213	36" x 24"

SPIDER®  
SHELVING SYSTEM

# Industrial Shelving Proposals

Shown here are some of the most popular drawers in shelving models.

All models include welded closed upright and hook-on mounting brackets for Spider® shelving, allowing for quick and easy assembly;

Additional accessories available : panels (perforated, louvered and finishing panels), shelf dividers, doors, etc.;

To order an add-on unit, complete product number with A.

SEE PAGES 59-64

**IMPORTANT**

Drawer partitions are included in models.

**NOTE**

Drawer partitions are included in models.  
For drawers without partitioning, refer to the price list.  
Ex. : R5SEC-751801 with  
R5SEC-751802 without

Shelving with drawers must be anchored to the floor (anchoring kit included).



R5XEE-2001

Number of Compartments (layout code)						
Drawer dimensions	36" x 18"	36" x 24"	42" x 18"	42" x 24"	48" x 18"	48" x 24"
3" to 5"	24 (0518)	30 (0524)	20 (0512)	30 (0524)	32 (0724)	40 (0732)
6" to 8"	8 (0304)	12 (0308)	12 (0308)	12 (0308)	10 (0405)	15 (0410)
9" and higher	6 (0203)	9 (0206)	6 (0203)	8 (0304)	8 (0304)	8 (0304)

**NOTE** For inside drawer dimensions. SEE PAGES 130-131

## Shelving with 18", 24", 36" & 48" of Modular Drawers

### Shelving with 18" of Modular Drawers



R5SEE-871801

4 drawers :  
- 3-4" drawers  
- 1-6" drawer

75" H (5 shelves) or 87" H (6 shelves) shelving

W x D	75" H	87" H
36" x 18"	R5SEC-751801_	R5SEC-871801_
36" x 24"	R5SEE-751801_	<b>R5SEE-871801_</b>
42" x 18"	R5SGC-751801_	R5SGC-871801_
42" x 24"	R5SGE-751801_	R5SGE-871801_
48" x 18"	R5SHC-751801_	R5SHC-871801_
48" x 24"	R5SHE-751801_	R5SHE-871801_

### Shelving with 24" of Modular Drawers



R5SEE-872401

5 drawers :  
- 3-4" drawers  
- 2-6" drawers

75" H (5 shelves) or 87" H (6 shelves) shelving

W x D	75" H	87" H
36" x 18"	R5SEC-752401_	R5SEC-872401_
36" x 24"	R5SEE-752401_	<b>R5SEE-872401_</b>
42" x 18"	R5SGC-752401_	R5SGC-872401_
42" x 24"	R5SGE-752401_	R5SGE-872401_
48" x 18"	R5SHC-752401_	R5SHC-872401_
48" x 24"	R5SHE-752401_	R5SHE-872401_

### Shelving with 36" of Modular Drawers



R5SEE-873601

7 drawers :  
- 3-4" drawers  
- 4-6" drawers

75" H (5 shelves) or 87" H (6 shelves) shelving

W x D	75" H	87" H
36" x 18"	R5SEC-753601_	R5SEC-873601_
36" x 24"	R5SEE-753601_	<b>R5SEE-873601_</b>
42" x 18"	R5SGC-753601_	R5SGC-873601_
42" x 24"	R5SGE-753601_	R5SGE-873601_
48" x 18"	R5SHC-753601_	R5SHC-873601_
48" x 24"	R5SHE-753601_	R5SHE-873601_



R5SEE-873603

7 drawers :  
- 4-4" drawers  
- 2-6" drawers  
- 1-8" drawer

75" H (5 shelves) or 87" H (6 shelves) shelving

W x D	75" H	87" H
36" x 18"	R5SEC-753603_	R5SEC-873603_
36" x 24"	R5SEE-753603_	<b>R5SEE-873603_</b>
42" x 18"	R5SGC-753603_	R5SGC-873603_
42" x 24"	R5SGE-753603_	R5SGE-873603_
48" x 18"	R5SHC-753603_	R5SHC-873603_
48" x 24"	R5SHE-753603_	R5SHE-873603_

## Shelving with 48" of Modular Drawers

SPIDER®  
SHELVING SYSTEM



R5SEE-874801

8 drawers :  
- 8-6" drawers  
75" H (4 shelves) or 87" H (5 shelves) shelving

W x D	75" H	87" H
36" x 18"	R5SEC-754801_	R5SEC-874801_
36" x 24"	R5SEE-754801_	<b>R5SEE-874801_</b>
42" x 18"	R5SGC-754801_	R5SGC-874801_
42" x 24"	R5SGE-754801_	R5SGE-874801_
48" x 18"	R5SHC-754801_	R5SHC-874801_
48" x 24"	R5SHE-754801_	R5SHE-874801_



R5SEE-874803

9 drawers :  
- 4-4" drawers  
- 4-6" drawers  
- 1-8" drawer  
75" H (4 shelves) or 87" H (5 shelves) shelving

W x D	75" H	87" H
36" x 18"	R5SEC-754803_	R5SEC-874803_
36" x 24"	R5SEE-754803_	<b>R5SEE-874803_</b>
42" x 18"	R5SGC-754803_	R5SGC-874803_
42" x 24"	R5SGE-754803_	R5SGE-874803_
48" x 18"	R5SHC-754803_	R5SHC-874803_
48" x 24"	R5SHE-754803_	R5SHE-874803_



R5SEE-874805

10 drawers :  
- 6-4" drawers  
- 4-6" drawers  
75" H (4 shelves) or 87" H (5 shelves) shelving

W x D	75" H	87" H
36" x 18"	R5SEC-754805_	R5SEC-874805_
36" x 24"	R5SEE-754805_	<b>R5SEE-874805_</b>
42" x 18"	R5SGC-754805_	R5SGC-874805_
42" x 24"	R5SGE-754805_	R5SGE-874805_
48" x 18"	R5SHC-754805_	R5SHC-874805_
48" x 24"	R5SHE-754805_	R5SHE-874805_



R5SEE-874807

11 drawers :  
- 4-3" drawers  
- 3-4" drawers  
- 4-6" drawers  
75" H (4 shelves) or 87" H (5 shelves) shelving

W x D	75" H	87" H
36" x 18"	R5SEC-754807_	R5SEC-874807_
36" x 24"	R5SEE-754807_	<b>R5SEE-874807_</b>
42" x 18"	R5SGC-754807_	R5SGC-874807_
42" x 24"	R5SGE-754807_	R5SGE-874807_
48" x 18"	R5SHC-754807_	R5SHC-874807_
48" x 24"	R5SHE-754807_	R5SHE-874807_



R5SEE-874809

7 drawers :  
- 2-3" drawers  
- 3-4" drawers  
- 2-6" drawers  
1 front access roll-out shelf  
75" H (4 shelves) or 87" H (5 shelves) shelving

W x D	75" H	87" H
36" x 18"	R5SEC-754809_	R5SEC-874809_
36" x 24"	R5SEE-754809_	<b>R5SEE-874809_</b>
42" x 18"	R5SGC-754809_	R5SGC-874809_
42" x 24"	R5SGE-754809_	R5SGE-874809_
48" x 18"	R5SHC-754809_	R5SHC-874809_
48" x 24"	R5SHE-754809_	R5SHE-874809_

# Industrial Shelving Accessories

## Dividers

### Shelf Divider

### SH50

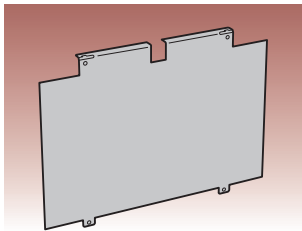

Dividers are attached one into the other;  
2 nylon clips provided with each divider;



Nominal dimensions (c/c with shelves);  
Offered in painted steel.

Product #	D x H
SH50-1206	12" x 6"
SH50-1209	12" x 9"
SH50-1212	12" x 12"
SH50-1215	12" x 15"
SH50-1218	12" x 18"
SH50-1506	15" x 6"
SH50-1512	15" x 12"
SH50-1806	18" x 6"
SH50-1809	18" x 9"
SH50-1812	18" x 12"
SH50-1815	18" x 15"
SH50-1818	18" x 18"
SH50-1824	18" x 24"

Product #	D x H
SH50-2406	24" x 6"
SH50-2409	24" x 9"
SH50-2412	24" x 12"
SH50-2415	24" x 15"
SH50-2418	24" x 18"
SH50-2424	24" x 24"

#### Dividers for X-ray Storage

SH50-1816	18" x 16"
SH50-1820	18" x 20"

Other sizes available. Contact your customer service representative for further information.

### Partial Divider

**PATENTED**

### SH52

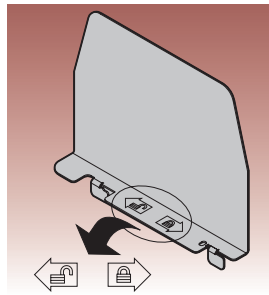

Pictograms make installation easy



Innovative patented divider, facilitates easy position changes;

Height : 5 1/2";

Easy installation, without tools.

Product #	Divider Depth	For Shelves
SH52-1206	7 1/8"	12" D
SH52-1506	10 1/8"	15" D
SH52-1806	13 1/8"	18" D
SH52-2406	19 1/8"	24" D



SHE3062



### Dividing Rods

### SH56

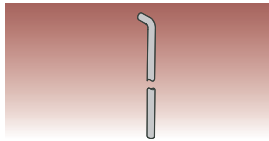

Sold in pairs;

Steel rod with 1/4" diameter;

90° fold at one end to ensure it stays in place;

Superior rigidity to plastic rods currently used on the market for this type of application.



SRP0410

Product #	Height
SH56-72	72"
SH56-84	84"
SH56-96	96"

## Label Holders

### Magnetic Label Holder

### SH82



Magnetic plastic;

Comes in 6" lengths and can be cut with scissors or a knife;

Note : Paper strips are not included with label holder.

Product #	W x H
SH82-600	6" x 1"

### Self-Adhesive Label Holder

### SH81



Attaches to surface with self-adhesive strip;

To be used with paper;

Full width;

Note : Paper strips are not included with label holder.

Product #	W x H
SH81-36	36" x 1"
SH81-42	42" x 1"
SH81-48	48" x 1"



## Panels and Doors

### Finishing Panel

### SH37

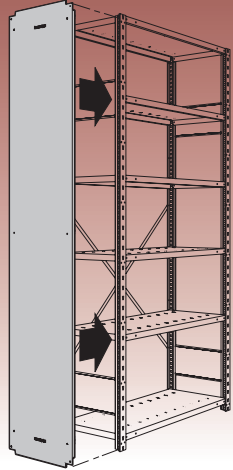

Finishing panel for end of aisle unit;  
Fast and easy hook-on assembly;  
Polished look;  
Compatible with some multi-level shelving applications. Contact our customer service.

Product #	D x H
SH37-12075	12" x 75"
SH37-12087	12" x 87"
SH37-18075	18" x 75"
SH37-18087	18" x 87"
SH37-24075	24" x 75"
SH37-24087	24" x 87"

### Perforated Panel

### SH38

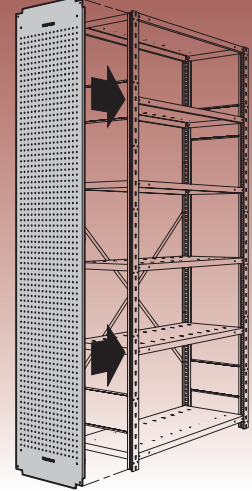

Perforated panel for end of aisle unit;  
Holes at every inch c/c;  
Compatible with WM94, WM95, WM96, WM97, WM98 and WM99 hooks;  
Fast and easy hook-on assembly;  
Polished look;  
Compatible with some multi-level shelving applications. Contact our customer service.

Product #	D x H
SH38-12075	12" x 75"
SH38-12087	12" x 87"
SH38-18075	18" x 75"
SH38-18087	18" x 87"
SH38-24075	24" x 75"
SH38-24087	24" x 87"

### Perforated Back Panel

### SR39

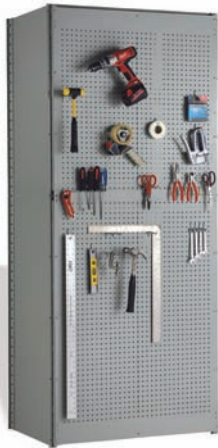

Perforated panel for shelving back;  
Easy to install;  
Compatible with SH31 back panels;  
Installs on the back of an existing shelving unit;  
Holes at every c/c;  
Compatible with WM94, WM95, WM96, WM97 and WM99 hooks;

Panel combinations :  
- 75" H posts (39" + 39")  
- 87" H posts (39" + 51")  
- 99" H posts (51" + 51")

Compatible with the up right SR with the perforated surface.

Product #	W x H
SR39-3639	36" x 39"
SR39-3651	36" x 51"
SR39-4239	42" x 39"
SR39-4251	42" x 51"
SR39-4839	48" x 39"
SR39-4851	48" x 51"

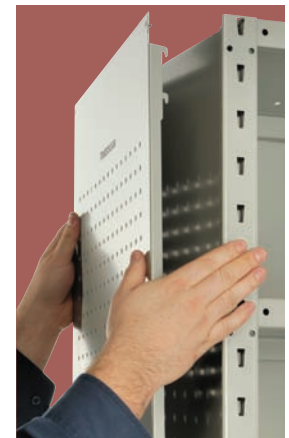

### Back or Side Louvered Panel

### SH65 / SH66

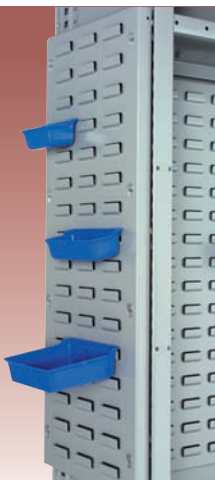

SH65 louvered panel for back of shelving : installs on the inside of the shelving unit, between two shelves;

SH66 louvered panel for side of shelving : installs on either the inside or the outside of the upright;

Simple assembly, no tools required;

Used for hanging RG20 bins;

Compatible with all brands of plastic bins offered on the market that are equipped with a hanging lip.

Back	W x H	Side	D x H
SH65-3621	36" x 21"	SH66-1221	12" x 21"
SH65-3633	36" x 33"	SH66-1233	12" x 33"
SH65-4221	42" x 21"	SH66-1821	18" x 21"
SH65-4233	42" x 33"	SH66-1833	18" x 33"
SH65-4821	48" x 21"	SH66-2421	24" x 21"
SH65-4833	48" x 33"	SH66-2433	24" x 33"

### Flipper Door

### SH85



Full-width handle;  
Standard lock included;  
14" high door that will allow you to store folders. Also available : 16" high door which will allow you to store binders;  
Installs between 2-SH20 shelves;  
SH52 dividers can be installed;  
Door heights available : 14", 16", 17" and 18";  
Order by adding the door height to the part #.  
Ex. : SH85-361816L3.

Product #	Width
SH85-3618_L3	36"
SH85-4218_L3	42"
SH85-4818_L3	48"
SH85-3624_L3	36"
SH85-4224_L3	42"
SH85-4824_L3	48"



# Industrial Shelving Accessories

## Doors

## SH40

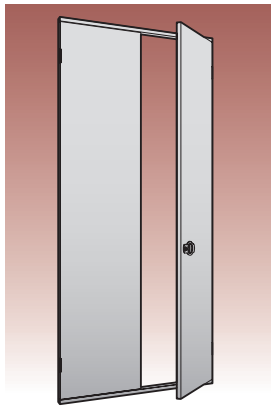

Doors open 180°, with recessed lock and handle;  
To receive a safety hasp instead of a standard lock, order SH40-XXXXLP instead of SH40-XXXXL3;  
Simple and fast assembly;  
Frame spaced to allow for installation of Rousseau modular drawers;  
Compatible with Rousseau Spider® shelving only.

Product #	W x H
SH40-3639L3	36" x 39"
SH40-3675L3	36" x 75"
SH40-3687L3	36" x 87"
SH40-3699L3	36" x 99"
SH40-4239L3	42" x 39"
SH40-4275L3	42" x 75"
SH40-4287L3	42" x 87"
SH40-4299L3	42" x 99"
SH40-4839L3	48" x 39"
SH40-4875L3	48" x 75"
SH40-4887L3	48" x 87"
SH40-4899L3	48" x 99"



SHQ0010

## Glass Doors

## SH42

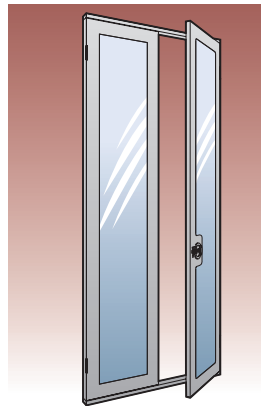

Doors with glass panels ensure you can see contents;  
Surface made of polycarbonate with excellent impact resistance;  
Doors open 180°, with recessed lock and handle;  
To receive a safety hasp instead of a standard lock, order SH40-XXXXLP instead of SH40-XXXXL3;  
Simple and fast assembly;  
Frame spaced to allow for installation of Rousseau modular drawers;  
Compatible with Rousseau Spider® shelving only.

Product #	W x H
SH42-3639L3	36" x 39"
SH42-3675L3	36" x 75"
SH42-3687L3	36" x 87"
SH42-3699L3	36" x 99"
SH42-4239L3	42" x 39"
SH42-4275L3	42" x 75"
SH42-4287L3	42" x 87"
SH42-4299L3	42" x 99"
SH42-4839L3	48" x 39"
SH42-4875L3	48" x 75"
SH42-4887L3	48" x 87"
SH42-4899L3	48" x 99"



SHQ0011 SHQ0012

## Miscellaneous Rails

### Clothes Hanging Rail

### SH70

### Spool Support

### SH72

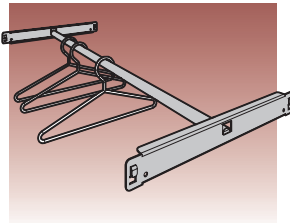

80 lb capacity per rail;  
Simple and fast installation;  
Installs by hooking to the shelving posts;  
Includes one bar with a 1" diameter and 2 adaptors ;  
Note : Because of space required under the clothes rail, it is not recommended for use on two-level shelving installations.

Product #	W x D
SH70-3618	36" x 18"
SH70-3624	36" x 24"
SH70-4218	42" x 18"
SH70-4224	42" x 24"
SH70-4818	48" x 18"
SH70-4824	48" x 24"

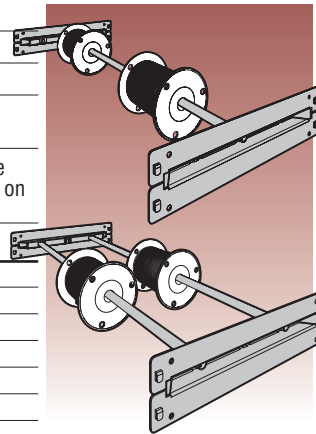

Optimizes storage of spools in shelving;  
Offered with one or two rails;  
50 lb capacity per rail, 100 lb total per double rail;  
Rail(s) with 3/4" diameter, compatible with most spools;  
Design allows for pivoting of rail to facilitate changing spools;  
Combinations possible for different sized spools.

Product #	W x D	# of Rails
SH72-3612-01	36" x 12"	1 rail
SH72-3618-01	36" x 18"	1 rail
SH72-3618-02	36" x 18"	2 rails
SH72-3624-01	36" x 24"	1 rail
SH72-3624-02	36" x 24"	2 rails
SH72-4212-01	42" x 12"	1 rail
SH72-4218-01	42" x 18"	1 rail
SH72-4218-02	42" x 18"	2 rails
SH72-4224-01	42" x 24"	1 rail
SH72-4224-02	42" x 24"	2 rails
SH72-4812-01	48" x 12"	1 rail
SH72-4818-01	48" x 18"	1 rail
SH72-4818-02	48" x 18"	2 rails
SH72-4824-01	48" x 24"	1 rail
SH72-4824-02	48" x 24"	2 rails

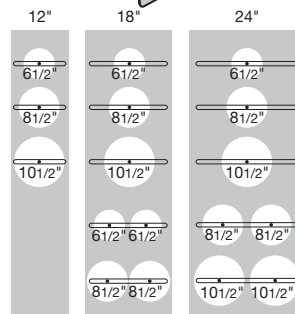

## Vinyl Rub-on Identification Decal

WM91



Allows you to easily identify where tools are to be positioned on the perforated panel (SH38, SH39 and SR39);

The contrasting color provides fast retrieval and shows if tools are missing, and which ones;

Efficient help for 5S management;

Sold in rolls 2 feet wide and 8 feet long.

**Product #**

WM91-01J

## Multiple Tool Holder

WM94



Used for WM51, WM53 and WM56 perforated panels to hang accessories or tools.

**Product #**      **W x H**

WM94-01      9" x 1 1/2"

## Straight Arm Hooks

WM96



Used for WM51, WM53 and WM56 perforated panels to hang accessories or tools;

Sold in packs of 20.

**Product #**      **Depth**

WM96-150      1 1/2"

## Double Back Single and Double Hooks

WM98 / WM99



Used for WM51, WM53 and WM56 perforated panels to hang accessories or tools;

Sold in packs of 10.

**Product #**      **Depth**      **Type**

WM98-03      3"      Single

WM98-05      5"      Single

WM99-03      3"      Double

WM99-05      5"      Double

## Screwdriver Holder

WM95



Used for WM51, WM53 and WM56 perforated panels to hang screwdrivers;

May store up to 6 screwdrivers.

**Product #**      **W x D x H**

WM95-01      9" x 1 1/2" x 1 3/4"

## Single Loop Hooks

WM97



Used for WM51, WM53 and WM56 perforated panels to hang accessories or tools;

Sold in packs of 20.

**Product #**      **Diameter**

WM97-150      1 1/2"

WM97-200      2"

## Plastic Bin Rail

SH62

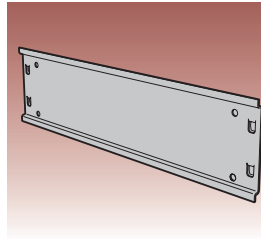

Very useful at ends of aisles. Fast hook-on assembly;

Ideal for all brands of bins from 5" to 7" high;

Bins sold separately.

**Product #**      **Depth**

SH62-18      18"

SH62-24      24"

## Plastic Bin



RG20

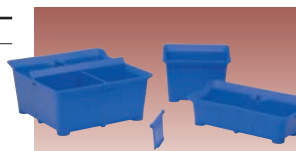

Makes storing, moving and inventory of small parts easier. Lightweight and resistant;

Edge at 45° angle for easy identification and easy removal of parts;

Compatible with louvered panels (SH65, SH66, WM55) and plastic bin rails (SH62 and WM28);

6" bins can be partitioned.

Dimensions			Bin	Product # Partition	Divider
W	D	H			
4"	3"	2"	RG20-040302	-	-
6"	3"	2"	RG20-060302	RG22-0302	-
6"	6"	2"	RG20-060602	RG22-0602	RG24-0602
4"	3"	3"	RG20-040303	-	-
6"	3"	3"	RG20-060303	RG22-0303	-
6"	6"	3"	RG20-060603	RG22-0603	RG24-0603

**NOTE**

Compatible with perforated panels with 1/4" holes at every 1" c/c. These panels are among the most popular on the market.



SHQ0013

Unit with closed welded upright



SHQ0014

Unit with SH37 finishing panel



SHQ0015

Unit with SH38 perforated panel

# Industrial Shelving Accessories

## Modular Drawers and Roll-out Shelves

### Heavy-Duty Modular Drawer for Shelving

RF32

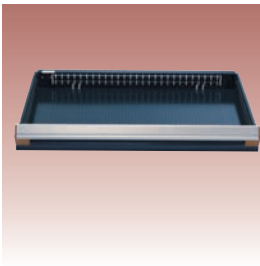

400 lb capacity, 100% extension;

Heavy-duty construction;

Easy to install;

Vast choice of accessories offered to adapt to your storage needs;

Available drawer heights : 3", 4", 5", 6", 7", 8", 9", 10", 12" and 14";

Order by adding the drawer height to the part #.  
Ex. : RF32-362406;

For modular drawers with layouts,

SEE PAGES  
147-151

SEE PAGES  
133-146

Product #	W x D
RF32-3618	36" x 18"
RF32-3624	36" x 24"
RF32-4218	42" x 18"
RF32-4224	42" x 24"
RF32-4818	48" x 18"
RF32-4824	48" x 24"

### Heavy-Duty Front Access Roll-Out Shelf

RF41



400 lb capacity, 100% extension;

Heavy-duty construction;

Easy to install;

Painted steel with 3" edges on sides and back;

Height : 6";

Full access to contents.

Product #	W x D
RF41-3618	36" x 18"
RF41-3624	36" x 24"
RF41-4218	42" x 18"
RF41-4224	42" x 24"
RF41-4818	48" x 18"
RF41-4824	48" x 24"

### Heavy-Duty 3-Sided Access Roll-Out Shelf

RF45

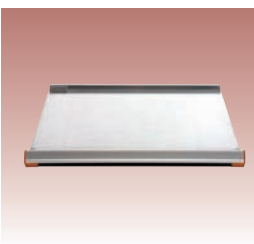

400 lb capacity, 100% extension;

Heavy-duty construction;

Easy to install;

Galvanized steel with 1 1/2" edge on back;

Height : 5";

May serve as work surface.

Product #	W x D
RF45-3618	36" x 18"
RF45-3624	36" x 24"
RF45-4218	42" x 18"
RF45-4224	42" x 24"
RF45-4818	48" x 18"
RF45-4824	48" x 24"

### Mounting Brackets for Spider® Shelving

RE30

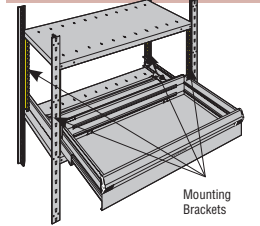
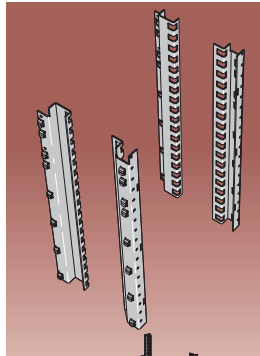

Easy hook-on assembly;

Standard heights : 18", 24", 30", 34", 36", 46" and 48";

The mounting bracket kit is compatible with all drawer widths for Rousseau shelving (36", 42" and 48");

Each kit includes 2 front and 2 rear mounting brackets and all necessary hardware;

Holes at every 1" c/c for drawer adjustment;

Two mounting bracket sets may be stacked simply by installing a shelf between them;

34" high mounting brackets are used with 39" posts or doors;

To order mounting brackets of non-standard heights, contact our customer service representative.

Product #	Height
RE30-18	18"
RE30-24	24"
RE30-30	30"
RE30-34	34"
RE30-36	36"
RE30-46	46"
RE30-48	48"

SEE PAGE  
81

SPIDER®  
SHELVING SYSTEM

**Shelving units with drawers must be anchored to the ground.**

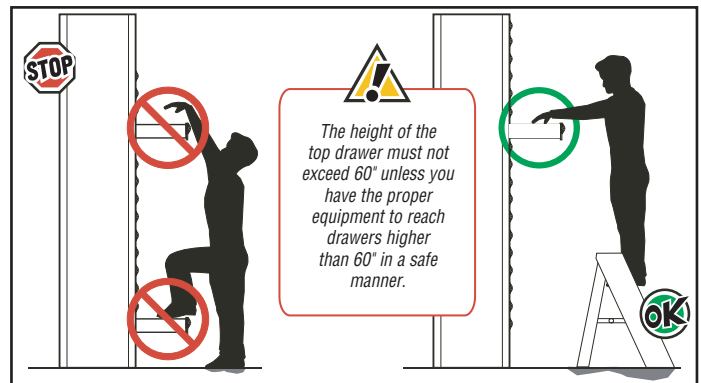

### Heavy-Duty 3-Sided Access Roll-Out Shelf

RF45

Filler

RE90

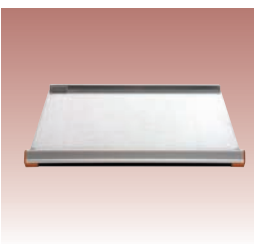

400 lb capacity, 100% extension;

Heavy-duty construction;

Easy to install;

Galvanized steel with 1 1/2" edge on back;

Height : 5";

May serve as work surface.

Product #	W x D
RF45-3618	36" x 18"
RF45-3624	36" x 24"
RF45-4218	42" x 18"
RF45-4224	42" x 24"
RF45-4818	48" x 18"
RF45-4824	48" x 24"

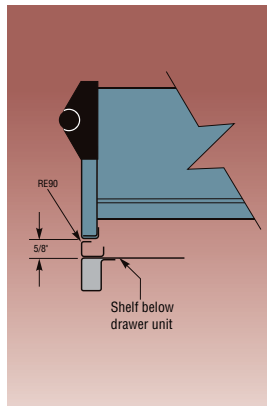

Installs with an adhesive strip under the bank of drawers;

Meets aesthetic requirements of certain work environments (hospitals, offices, etc.);

Offered for Rousseau Spider® and spacesaver shelving only;

For Spacesaver shelving, order RE90-XX02 instead of RE90-XX01.

Product #	W x H
RE90-3601	36" x 5/8"
RE90-4201	42" x 5/8"
RE90-4801	48" x 5/8"

## Locking and Security Mechanisms

### Vertical Security Bar

**RE80**



Locks a bank of drawers in shelving with either a key or a padlock;

To receive a safety hasp instead of a standard lock, order RE80-XXLPA instead of RE80-XXL3A;

Safety hasp for padlock is located at the top of the bar to facilitate access;

Covers a bank of drawers from 18" to 48" high;

Easy hook-on assembly;

Possible to install more than one bar on the same bracket for different users;

Installs on the right side;

36" high bar is compatible with 34" high mounting brackets and 48" high bar is compatible with 46" high mounting brackets;

Order by completing the product number with the type of key;

Offered for Rousseau Spider® shelving. For Spacesaver shelving, order RE81-XXXXA instead of RE80-XXXXA.



Product #	Height
RE80-18L3A	18"
RE80-24L3A	24"
RE80-30L3A	30"
RE80-36L3A	36"
RE80-48L3A	48"

### Integrated Lock-in Mechanism



**A**



Activated by tilting the handle up;

Allows user to open the drawer and the roll-out shelf with one hand only;

Close by simply pushing it;

Stops drawer and roll-out shelf from opening on their own;

Easy to retrofit;

Order by adding A to the drawer or partitioning model number or roll-out shelf. Ex. : RF32-362406A.

**Product #**  
A

### Econo Lock-in Mechanism

**B**

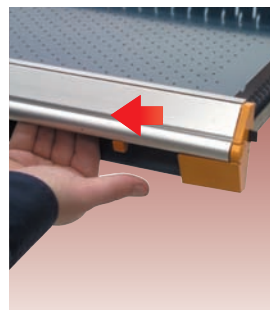

Activated with the right hand by sliding the mechanism with thumb;

Drawer and roll-out shelf closes without having to reactivate the slide mechanism;

Stops drawer and roll-out shelf from opening on their own;

Easy to retrofit;

Order by adding B to the drawer or partitioning model number or roll-out shelf; Ex. : RF32-362406B.

**Product #**  
B

### Lock-out Mechanism

**RF85**



For both drawers and roll-out shelves;

Locks drawers and roll-out shelves in open position;

Activated manually, only when required;

No interference with drawer accessories.

**Product #**  
RF85

### Drawer Lock

**L3**

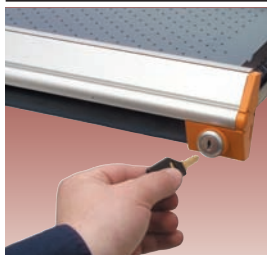

Compatible with all drawer dimensions;

Does not affect usable drawer space;

Easy to retrofit;

Order by adding L3 to drawer or partitioning model number. Ex. : RF32-362406L3.

**Product #**  
L3



### Security Panel

**RF91**

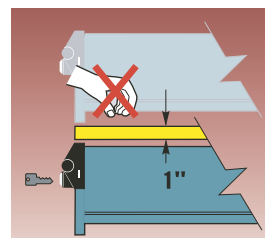

Blocks access between two drawers or two banks of drawers;

Usable space in the bank of drawers is reduced by 1";

Installed between two drawers.

Product #	W x D
RF91-3618	36" x 18"
RF91-3624	36" x 24"
RF91-4218	42" x 18"
RF91-4224	42" x 24"
RF91-4818	48" x 18"
RF91-4824	48" x 24"

# Mini-Racking Components

## Structural Components

### Post

### SR10/SH10

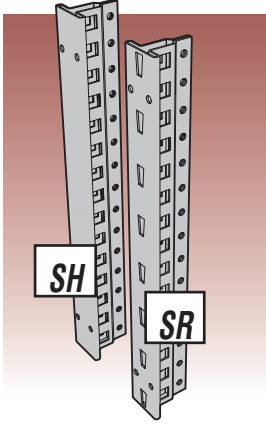

Tubular T-shape; up to 7 fixing zones;  
Perforations on sides at every 1" c/c for adjusting shelves;  
14 gauge steel;  
Choose either :  
- The universal SR10 post with the perforated surface to add Mini-Racking or two-level shelving  
- The shelving SH10 post with the smooth finish surface for enhanced appearance

SR universal post	SH shelving post	Height
SR10-039	SH10-039	39"
SR10-051	SH10-051	51"
SR10-075	SH10-075	75"
SR10-087	SH10-087	87"
SR10-099	SH10-099	99"
SR10-111	SH10-111	111"
SR10-123	SH10-123	123"

Other dimensions available. Contact your customer service representative.

### Welded Open Upright

### SR11/SH11

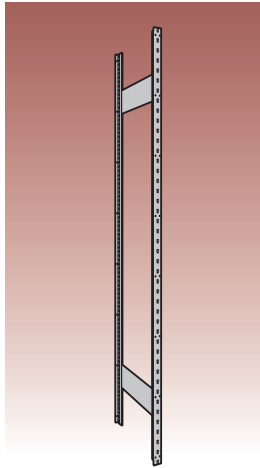

Upright with factory welded side braces;  
Fast assembly.

SR universal post	SH shelving post	D x H
SR11-120752	SH11-120752	12" x 75"
SR11-120872	SH11-120872	12" x 87"
SR11-120992	SH11-120992	12" x 99"
SR11-180752	SH11-180752	18" x 75"
SR11-180872	SH11-180872	18" x 87"
SR11-180992	SH11-180992	18" x 99"
SR11-240752	SH11-240752	24" x 75"
SR11-240872	SH11-240872	24" x 87"
SR11-240992	SH11-240992	24" x 99"

Other dimensions available. Contact your customer service representative.

### Side Braces

### SH34

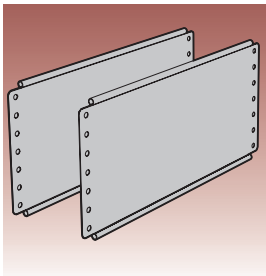

Sold in pairs;  
Allow upright assemblies to be fastened in a "ladder-like" manner for easier assembly;  
Recommendations :  
- 1 pair per upright assembly up to 99" in height  
- For upright assemblies over 99" in height, please refer to the S58 technical sheet or contact your customer service representative.

Product #	Depth
SH34-12	12"
SH34-15	15"
SH34-18	18"
SH34-24	24"
SH34-30	30"

### Welded Closed Upright

### SR12/SH12

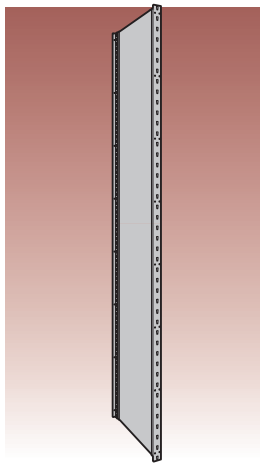

Upright with full-height factory welded parts;  
Fast assembly.

SR universal post	SH shelving post	D x H
SR12-12075	SH12-12075	12" x 75"
SR12-12087	SH12-12087	12" x 87"
SR12-12099	SH12-12099	12" x 99"
SR12-18075	SH12-18075	18" x 75"
SR12-18087	SH12-18087	18" x 87"
SR12-18099	SH12-18099	18" x 99"
SR12-24075	SH12-24075	24" x 75"
SR12-24087	SH12-24087	24" x 87"
SR12-24099	SH12-24099	24" x 99"

Other dimensions available. Contact your customer service representative.

### Back Brace

### SH33

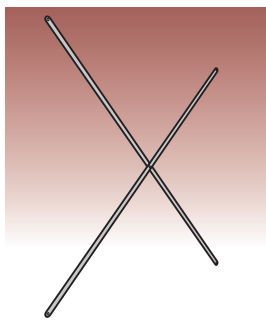

"X" shaped, factory assembled brace;  
Easy to install;  
Recommendations :  
- 1 pair per upright assembly up to 99" in height  
- 2 pairs for posts over 99" in height.  
Please refer to the S58 technical sheet or contact your customer service representative.

Product #	Width
SH33-36	36"
SH33-42	42"
SH33-48	48"

### Corner Gussets

### SH35

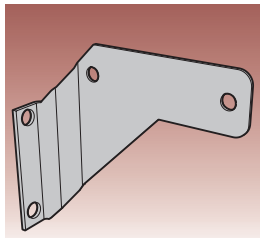

Replace back brace for full access to front and back of shelving unit;

14 gauge steel;

Each set includes 4 gussets. Min. of 3 sets per unit;

Note : Not to be used on units over 99" H or for two-level shelving.

Product #  
SH35

## Side Panel

## SH30

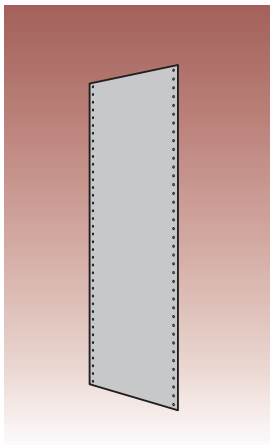

Panel combinations :

- 75"H posts (39" + 39")
- 87"H posts (39" + 51")
- 99"H posts (51" + 51")
- 111"H posts (39" + 39" + 39")
- 123"H posts (39" + 39" + 51")

Product #	D x H
SH30-1239	12" x 39"
SH30-1251	12" x 51"
SH30-1539	15" x 39"
SH30-1551	15" x 51"
SH30-1839	18" x 39"
SH30-1851	18" x 51"
SH30-2439	24" x 39"
SH30-2451	24" x 51"

## Back Panel

## SH31

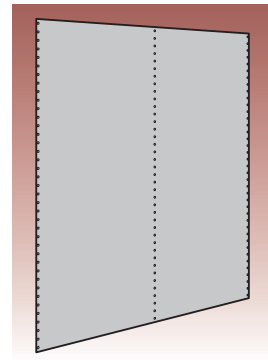

Panel combinations :

- 75"H posts (39" + 39")
- 87"H posts (39" + 51")
- 99"H posts (51" + 51")
- 111"H posts (39" + 39" + 39")
- 123"H posts (39" + 39" + 51")

Product #	W x H
SH31-3639	36" x 39"
SH31-3651	36" x 51"
SH31-4239	42" x 39"
SH31-4251	42" x 51"
SH31-4839	48" x 39"
SH31-4851	48" x 51"

## Structural Perforated Back Panel

## SH39

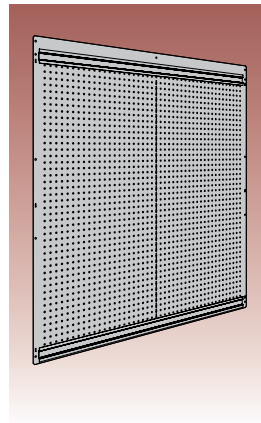

Perforated panel for shelving back;  
Integrated part of the shelving structure;  
Holes at every inch c/c;  
Compatible with WM94, WM95, WM96, WM97, WM98 and WM99 hooks;

Panel combinations :

- 75" H posts (39" + 39")
- 87" H posts (39" + 51")
- 99" H posts (51" + 51")

Note : Used without the SH31 back panels.

Product #	W x H
SH39-3639	36" x 39"
SH39-3651	36" x 51"
SH39-4239	42" x 39"
SH39-4251	42" x 51"
SH39-4839	48" x 39"
SH39-4851	48" x 51"

## Shelf Front or Front Base

## SH28

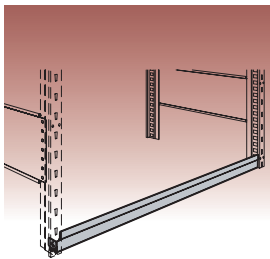

Same component for both applications;  
Fast hook-on installation;  
Note: Front base is always included with closed shelving models.

Product #	W x H
SH28-3602	36" x 2"
SH28-4202	42" x 2"
SH28-4802	48" x 2"
SH28-3605	36" x 5"
SH28-4205	42" x 5"
SH28-4805	48" x 5"

## Installation Accessories

### Floor Anchor Plate

### SH45

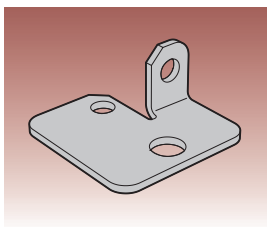

Sold individually;  
Attaches to the post for anchoring shelving sections to the floor. Distributes the load on a larger surface and protects the floor;  
12 gauge galvanized steel.

Product #
SH45

### Floor Anchoring Hardware

### SH47

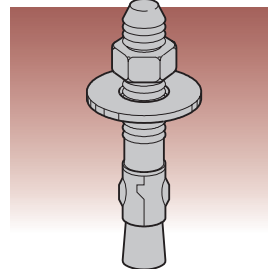

Used for anchoring shelving to the floor;  
Includes 4 cement screws.

Product #
SH47-04

### Shim Plate

### SH46

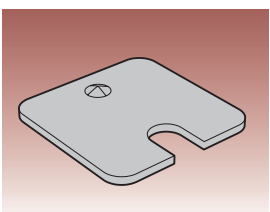

Sold individually;  
Evens out shelving units on uneven surfaces. Slides under SH45 floor anchor plate;  
12 or 16 gauge galvanized steel.

Product #	Thickness
SH46-12	12 gauge (0,100")
SH46-16	16 gauge (0,060")

### Wall Spacer

### SR47

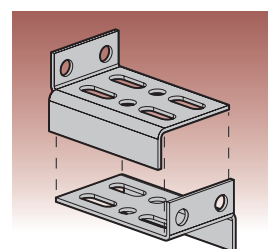

Designed to anchor shelving to the wall;  
Adjusts from 3" to 4";  
Wall anchoring hardware not included (holes are 5/16" in diameter).

Product #
SR47-0304

# Industrial Shelving Components

## Shelves and Shelf Accessories

### Box Shelf

### SH20

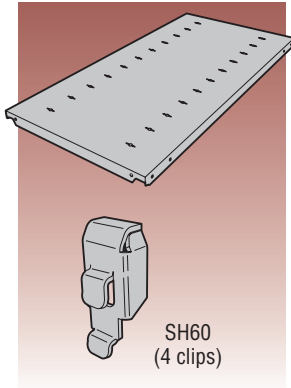

Box-type shelf with front and rear edges roll-formed and welded;  
20 gauge steel, 1 1/4" thick;  
4 sturdy and compact SH60 clips included;  
Perforations for dividers at every 3" c/c;  
Others dimensions available Contact your customer service representative.

Product #	W x D
SH20-3612	36" x 12"
SH20-3615	36" x 15"
SH20-3618	36" x 18"
SH20-3624*	36" x 24"
SH20-4212	42" x 12"
SH20-4215	42" x 15"
SH20-4218	42" x 18"
SH20-4224	42" x 24"
SH20-4812	48" x 12"
SH20-4815	48" x 15"
SH20-4818	48" x 18"
SH20-4824	48" x 24"

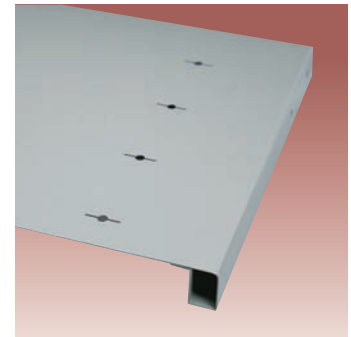

\* Also offered with a double fold on the sides.

### Shelf Load Capacity

Shelving load capacity tests are based on ANSI MH28.1 Shelving Manufacturer Association (SMA) standards. Capacities incorporate a safety factor and are valid for an equally distributed load. Capacities are indicated in pounds.

\*\* 800 lb capacity with SH22 side shelf reinforcers or shelf with double fold on the side.

Dimensions W x D	Shelf Reinforcement Diagrams		
	Medium-Duty Capacity Without Reinforcer	Heavy-Duty Capacity Central Reinforcer	Extra Heavy-Duty Capacity Double Reinforcer
36" x 12"	750	—	—
36" x 15"	775	—	—
36" x 18"	800	1000	1100
36" x 24"	625**	1050	1100
42" x 12"	650	—	—
42" x 15"	650	—	—
42" x 18"	650	850	1050
42" x 24"	650	875	1050
48" x 12"	550	—	—
48" x 15"	550	—	—
48" x 18"	575	725	1025
48" x 24"	600	750	1050

### Front Shelf Reinforcer

### SH24

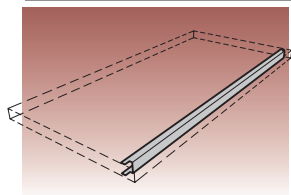

"C" shaped reinforcer. Used when shelves must support heavier loads in front. Note : The reinforcer increases shelf sturdiness, not capacity.

Product #	Width
SH24-36	36"
SH24-42	42"
SH24-48	48"

### Side Shelf Reinforcers

### SH22

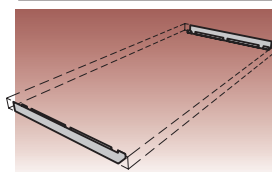

2 "L" shaped reinforcers for attachment on each side of a shelf. Used when shelves must support heavier loads.

Product #	Depth
SH22-18	18"
SH22-24	24"

### Double Shelf Supports

### SH25

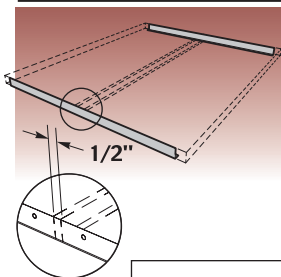

2 "L" shape supports. Used with two 15" shelves to obtain 30" depth (1/2" gap between shelves);

Total capacity : 750 lb.

Product #	Depth
SH25-30	30"

**NOTE**

The SH22, SH24 and SHC reinforcers as well as the SH25 double shelf supports are not factory installed on the SH20 box shelves.

### Center Shelf Reinforcer

### SHC

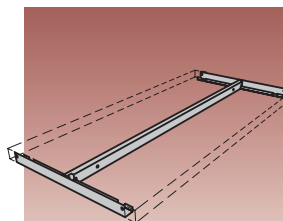

SH24 front shelf reinforcer combined with SH22 side reinforcers. Used when shelves must support heavier or more concentrated loads;

Note : An additional SH24 reinforcer should be ordered to obtain extra heavy-duty shelf capacity.

Product #	W x D
SHC1003	36" x 18"
SHC1004	36" x 24"
SHC1007	42" x 18"
SHC1008	42" x 24"
SHC1005	48" x 18"
SHC1006	48" x 24"