

FORK MOUNTED COIL RAM - CCF-36-5

APPROX WEIGHT: 321.18 lbs.
DOES NOT INCLUDE WEIGHT OF POWER OR PACKAGING!!!

*** ANY ADDITIONS, DELETIONS, OR OMISSIONS MUST BE CORRECTED ON THIS DRAWING AS THIS DRAWING WILL BE CONSIDERED ALL INCLUSIVE ***

ALL GRAPHICS PROVIDED ARE FOR REFERENCE ONLY. IF CERTAIN DIMENSIONS ARE CRITICAL PLEASE VERIFY THOSE DIMENSIONS WITH YOUR SALESPERSON

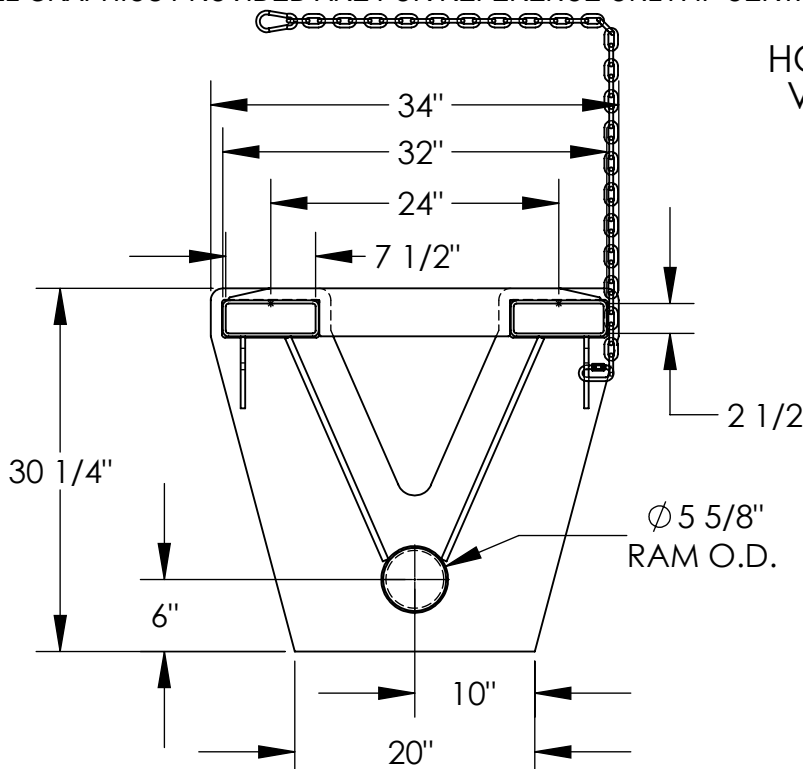

HORIZONTAL CENTER OF GRAVITY: 8.68"
VERTICAL CENTER OF GRAVITY: 15.83"
EFFECTIVE THICKNESS: LESS THAN 1"
LOST LOAD: 321.18 lbs.

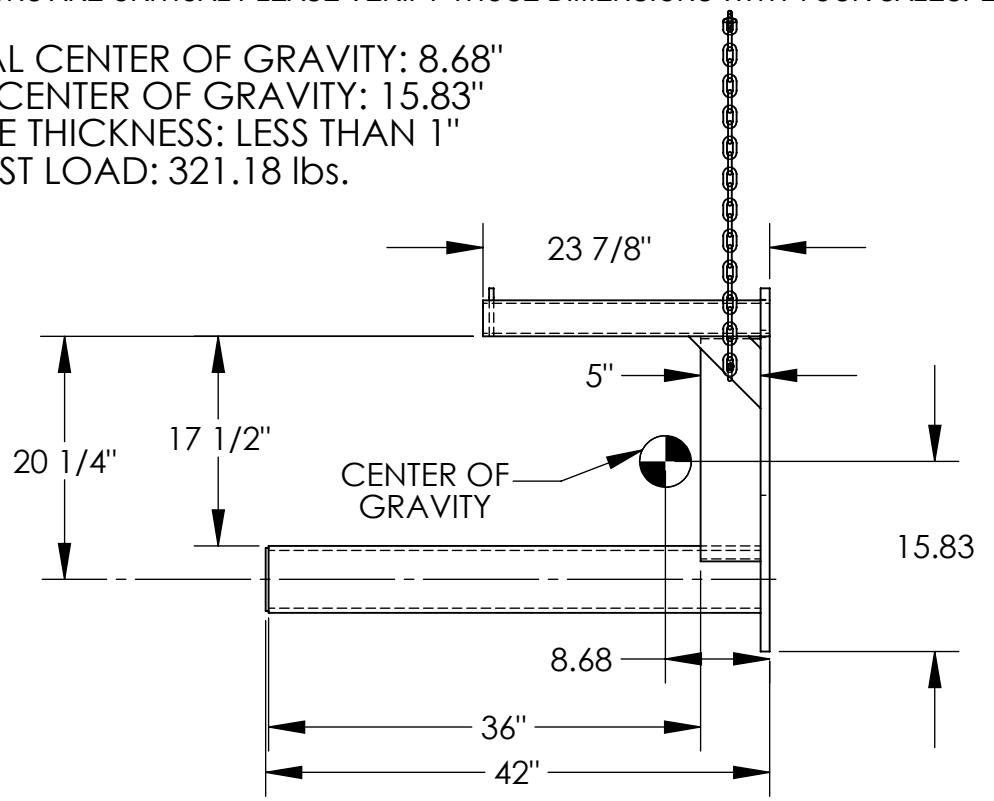

STANDARD FEATURES

- MODEL NUMBER IS CCF-36-5
- OVERALL WIDTH IS 34"
- OVERALL HEIGHT IS 30 1/4"
- USABLE RAM LENGTH IS 36"
- RAM O.D. IS 5 5/8"
- UNIFORM CAPACITY IS 5,500 LBS.
- STANDARD FORK POCKETS ARE 7 1/2" W x 2 1/2" H USABLE ON 24" CENTERS

SPECIAL FEATURES

NONE

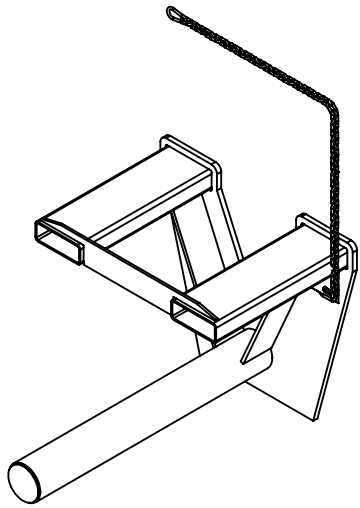

3-D VIEW SHOWN FOR REFERENCE ONLY
SCALE: 1:24

DIMENSION TOLERANCE ± 1/4"

APPROVAL	I, THE UNDERSIGNED, AGREE THAT THE PRODUCT AS REPRESENTED SATISFIES DESIGN AND DIMENSION REQUIREMENTS. I ALSO ACKNOWLEDGE MY DUTY TO CONFIRM PRODUCT AND INSTALLATION COMPLIANCE WITH ALL APPLICABLE FEDERAL, STATE AND LOCAL REGULATIONS AND STANDARDS.	
	ANY MODIFIED UNITS ARE NON-RETURNABLE	
	[] As drawn [] As marked	
	Signed: _____	Date: _____
Printed Name: _____		
LEAD TIME WILL START UPON RECEIPT OF SIGNED APPROVAL DRAWING		

FOR INTERNAL USE ONLY PROJECT SIGN OFF	
SALES	
ENG.	
FAB.	
POWER	

DISTRIBUTOR'S NAME:		P.O.#
VESTIL MANUFACTURING		X
DRAWN BY: B.NOTHNAGEL		W.O.#
DATE: 8/1/2015		X
REFERENCE: X	SCALE: 1:16	SALES: X
QUOTED LEAD TIME: X	QUOTE #	FILE NAME:
	X	08-007-267